

Инструкция по установке **HYUNDAI CRETA** (2016-)

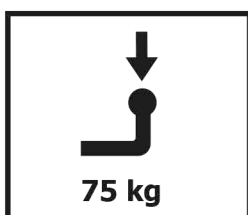

Арт.: F.2312.001

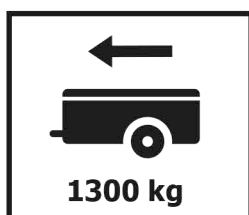

$D = 7.61 \text{ kN}$

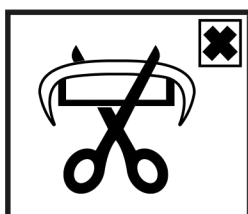

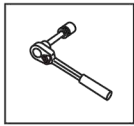
$$D \text{ (kN)} = \frac{\text{MAX kg} \times \text{x}}{\text{MAX kg} + \text{MAX kg}} \times 0,00981$$

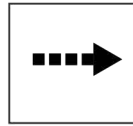

Вкрутить/выкрутить используя инструмент

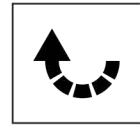

Движение



Поворот



Вкрутить/выкрутить не затягивая

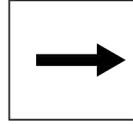





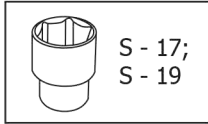
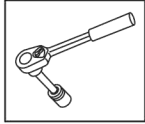



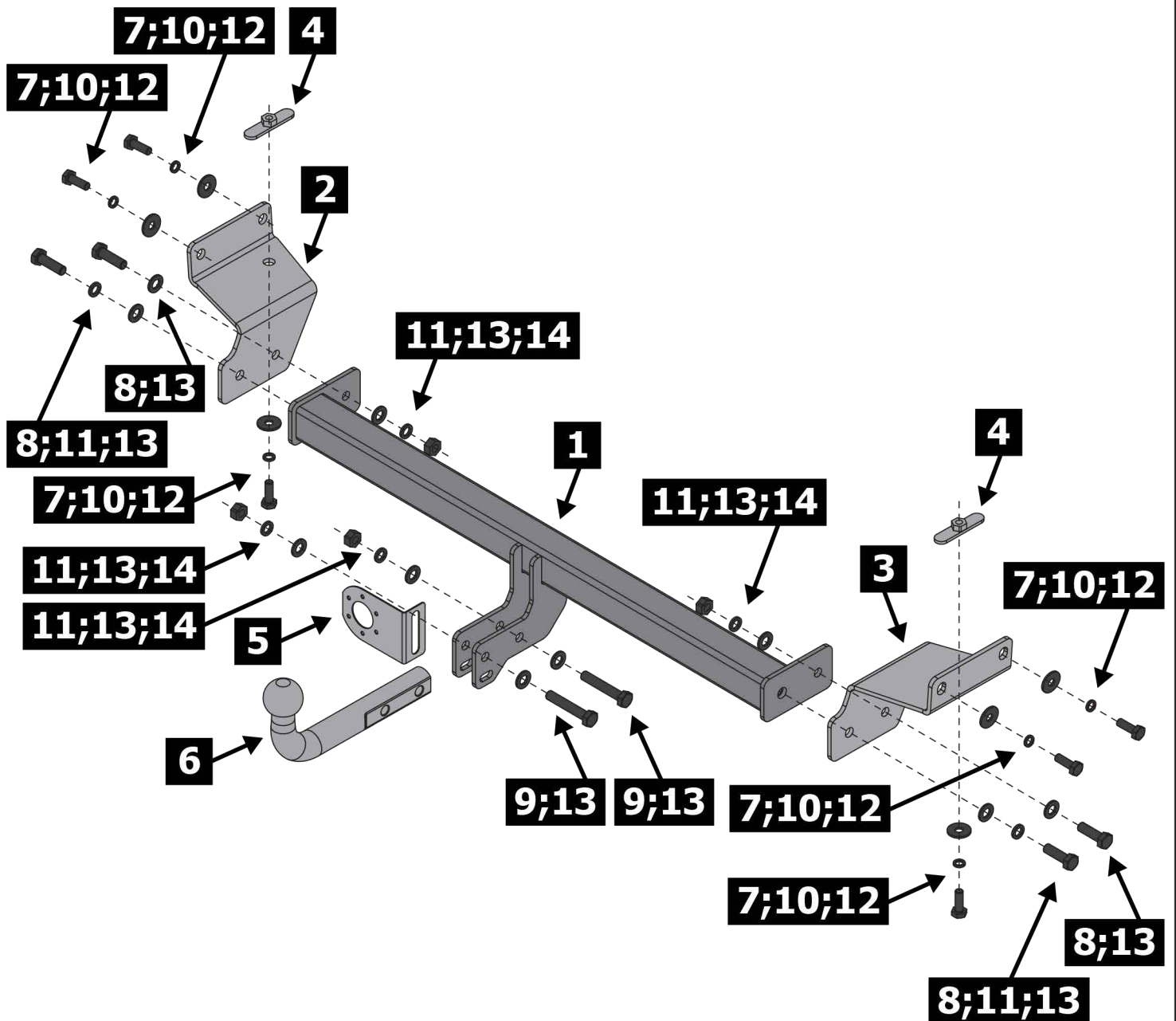

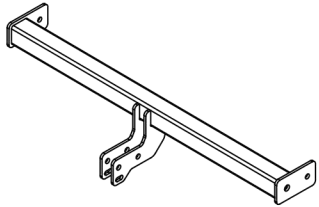
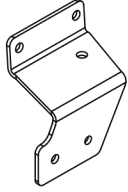
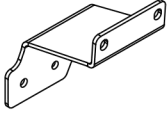
Расположение

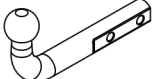
Используемый инструмент:



S - 17;
S - 19



| | | | |
|-----------|-----|------------------|---|
| 1 | x1 | Балка |  |
| 2 | x1 | Кронштейн левый |  |
| 3 | x1 | Кронштейн правый |  |
| 4 | x2 | Закладная гайка |  |
| 5 | x1 | Подрозетник |  |
| 6 | x1 | Крюк |  |
| 7 | x6 | M10x1.25x30 |  |
| 8 | x4 | M12x1.25x40 |  |
| 9 | x2 | M12x1.25x70 |  |
| 10 | x6 | ∅ 10 |  |
| 11 | x6 | ∅ 12 |  |
| 12 | x6 | ∅ 10 |  |
| 13 | x10 | ∅ 12 |  |
| 14 | x4 | M12x1.25 |  |
| | | | |
| | | | |

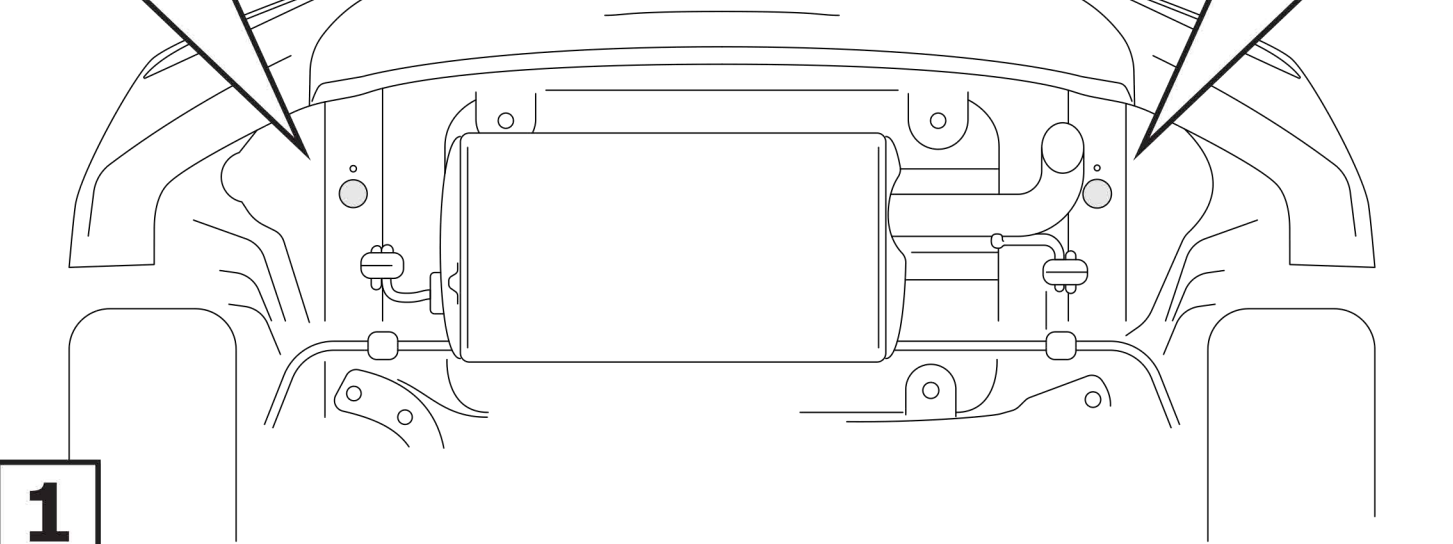
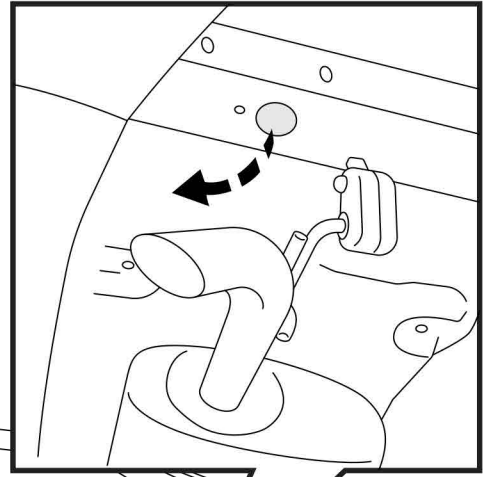
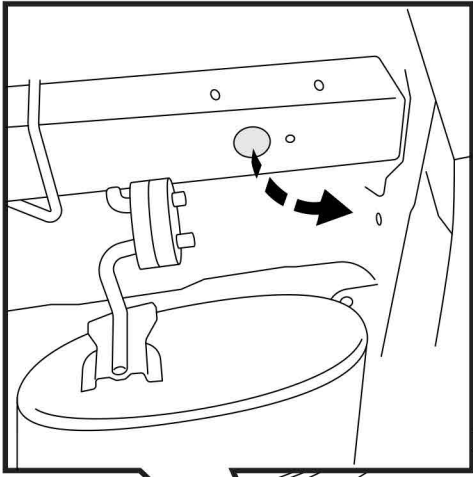

1

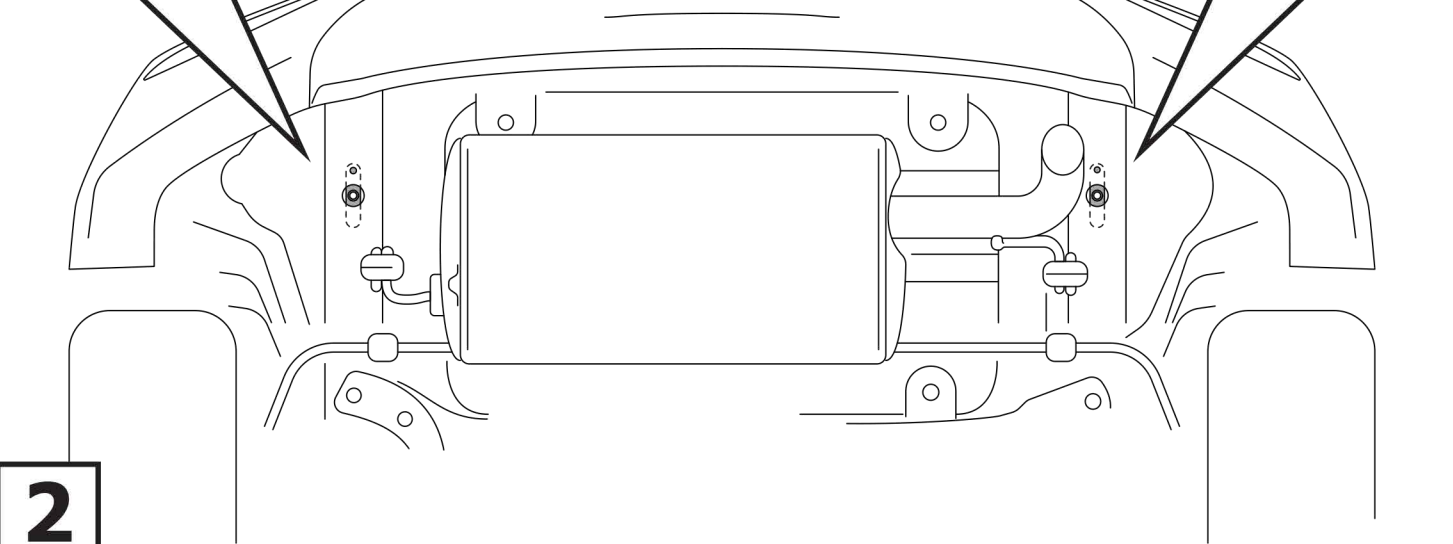
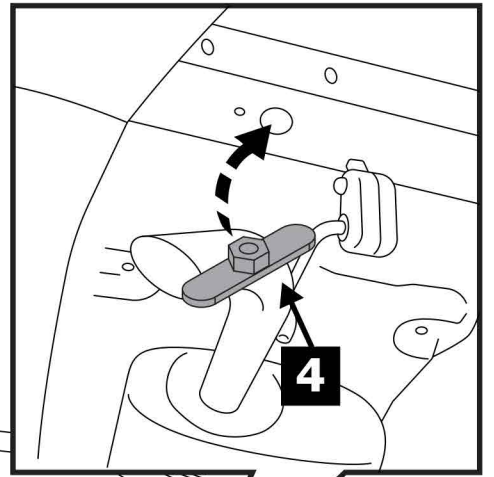
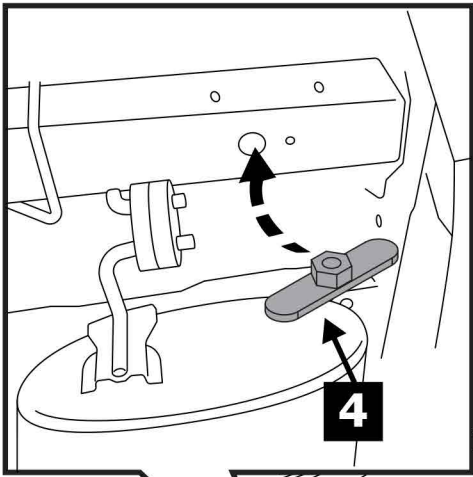

2

