

Инструкция по установке
MITSUBISHI OUTLANDER XL
(2006-2012)

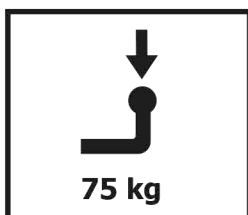

Арт.: F.4012.001

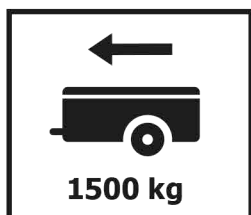

D = 8.7 kN

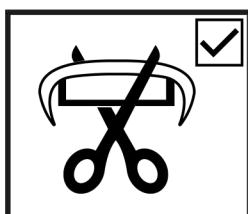

$$D \text{ (kN)} = \frac{\text{MAX kg} \times \text{MAX kg}}{\text{MAX kg} + \text{MAX kg}} \times 0,00981$$

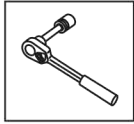

Вкрутить/выкрутить используя инструмент

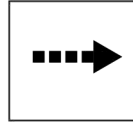

Движение

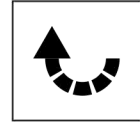

Поворот



Вкрутить/выкрутить не затягивая

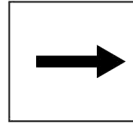

Расположение

Используемый инструмент:

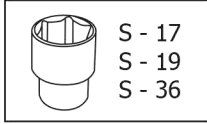
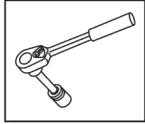







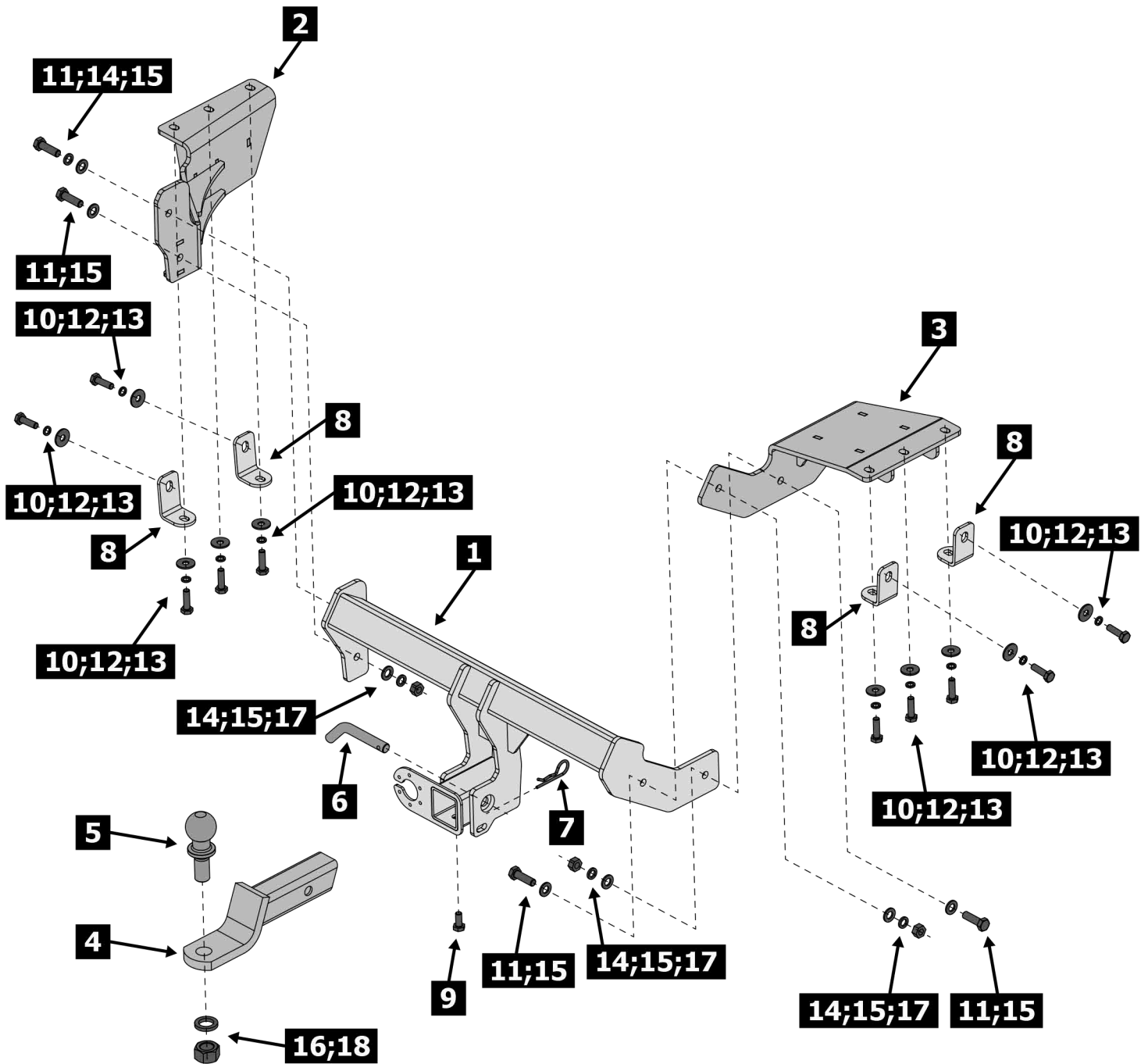

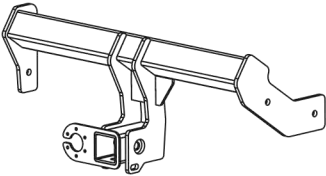
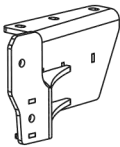
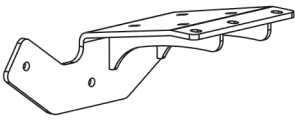

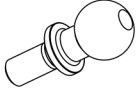

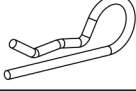

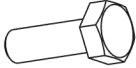

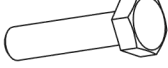
S - 17
S - 19
S - 36



Office Knife



1	x1	Балка	
2	x1	Кронштейн балки левый	
3	x1	Кронштейн балки правый	
4	x1	Переходник	
5	x1	Шар	
6	x1	Штифт	
7	x1	Шплинт	
8	x4	Уголок	
9	x1	M10x20	
10	x10	M10x1,25x35	
11	x4	M12x1,25x40	
12	x10	Ø10	
13	x10	Ø10	
14	x4	Ø12	
15	x7	Ø12	
16	x1	Ø24	
17	x3	M12x1,25	
18	x1	M24	

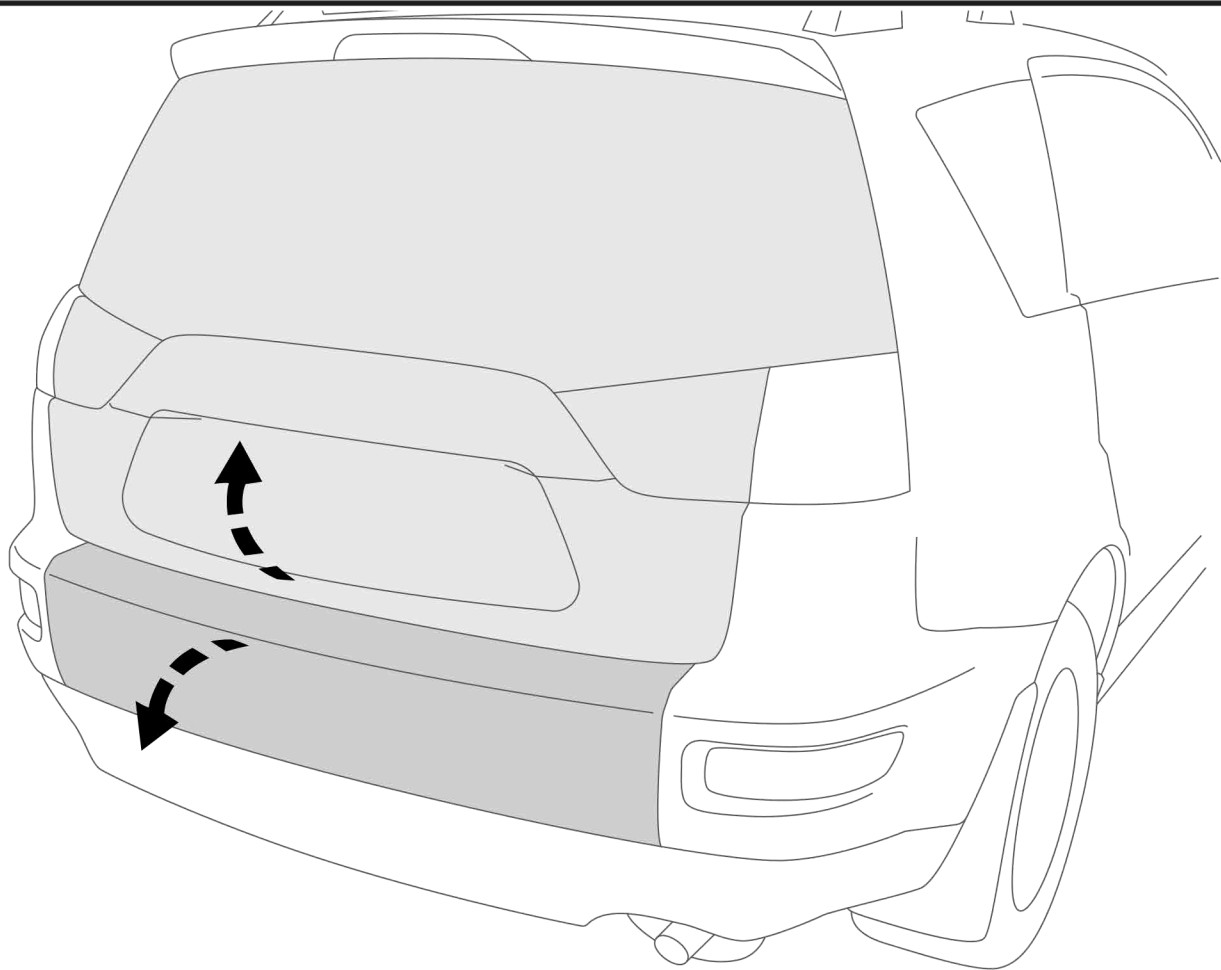

1

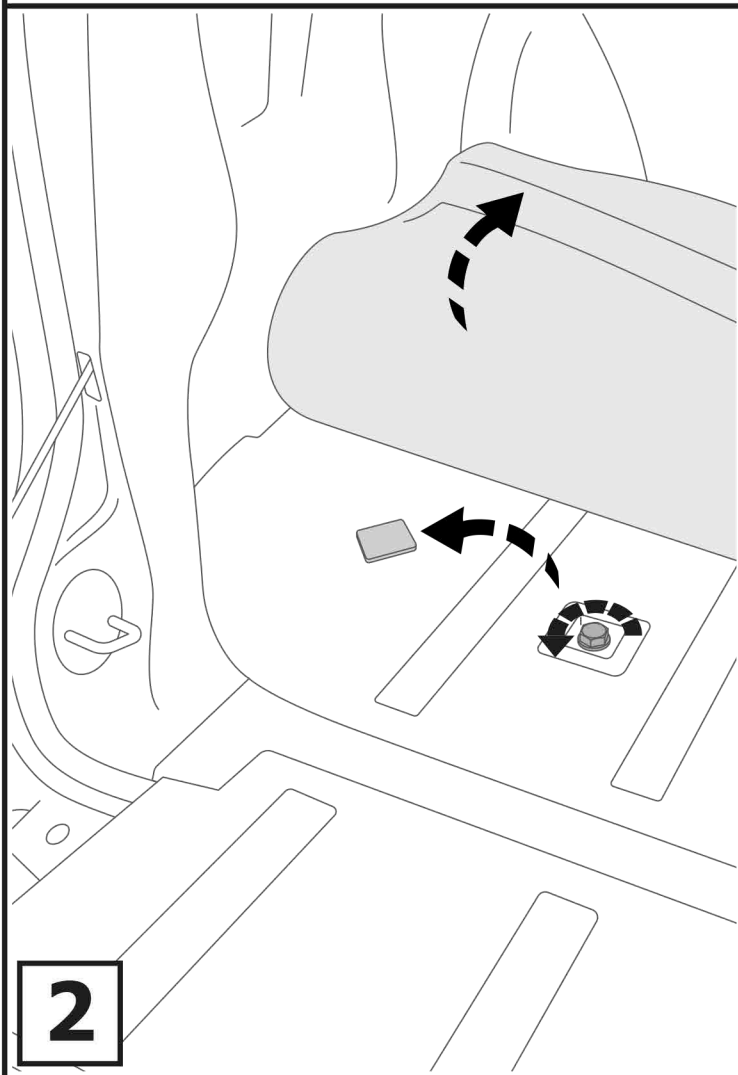

2

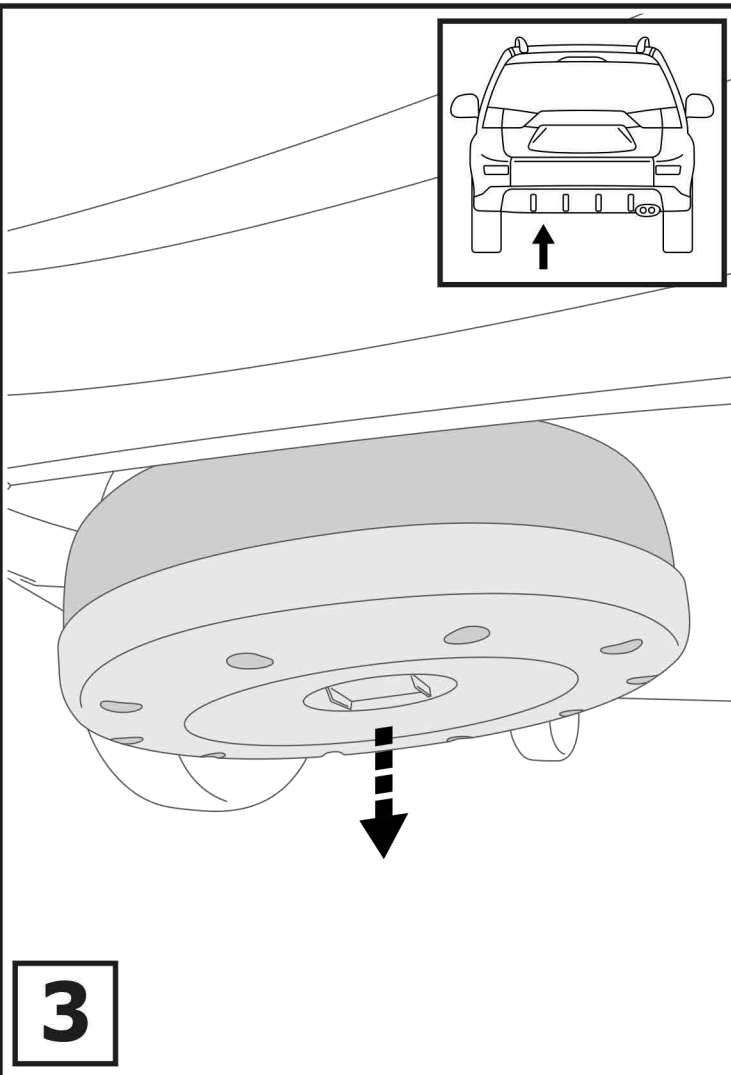

3

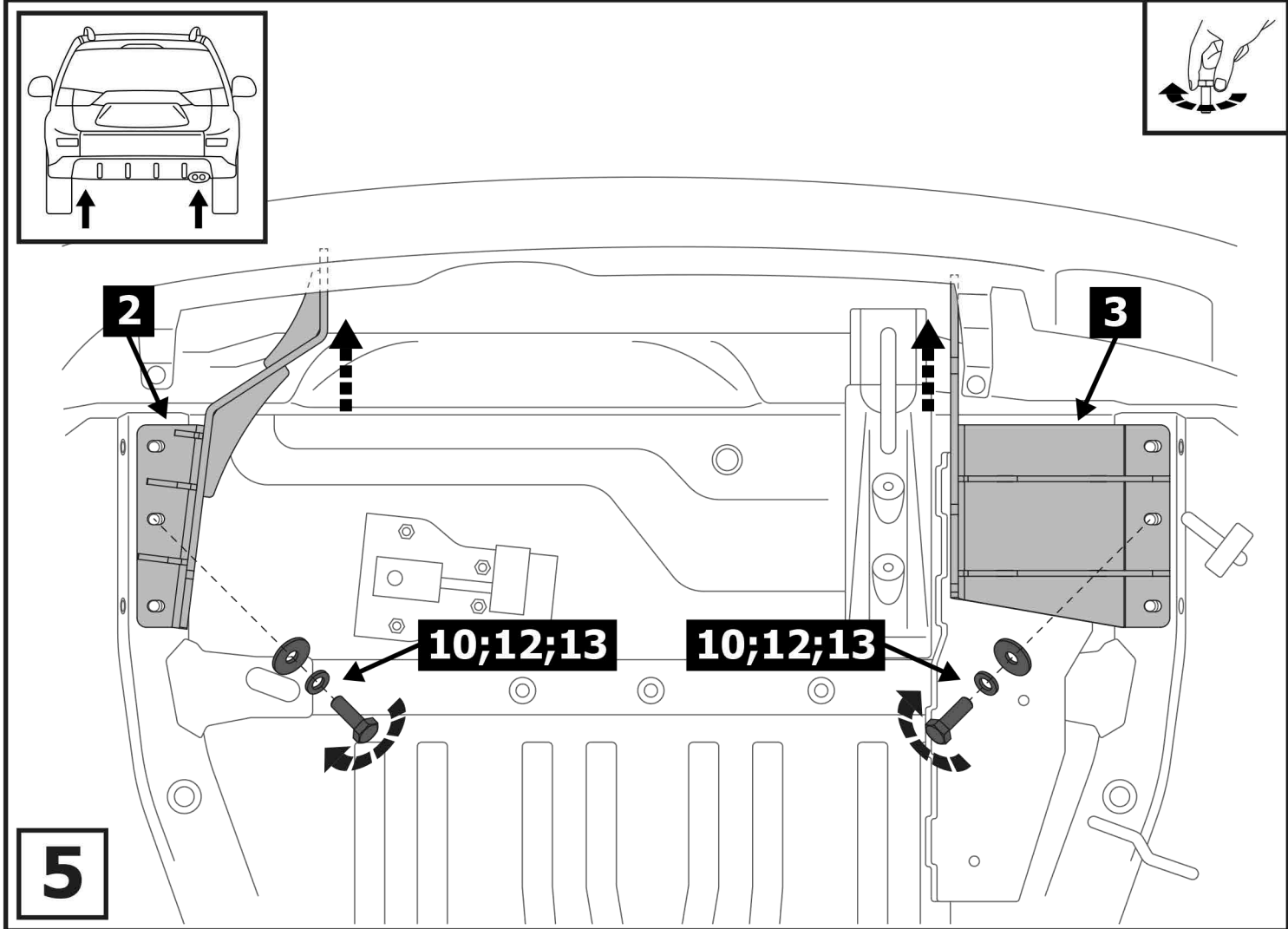
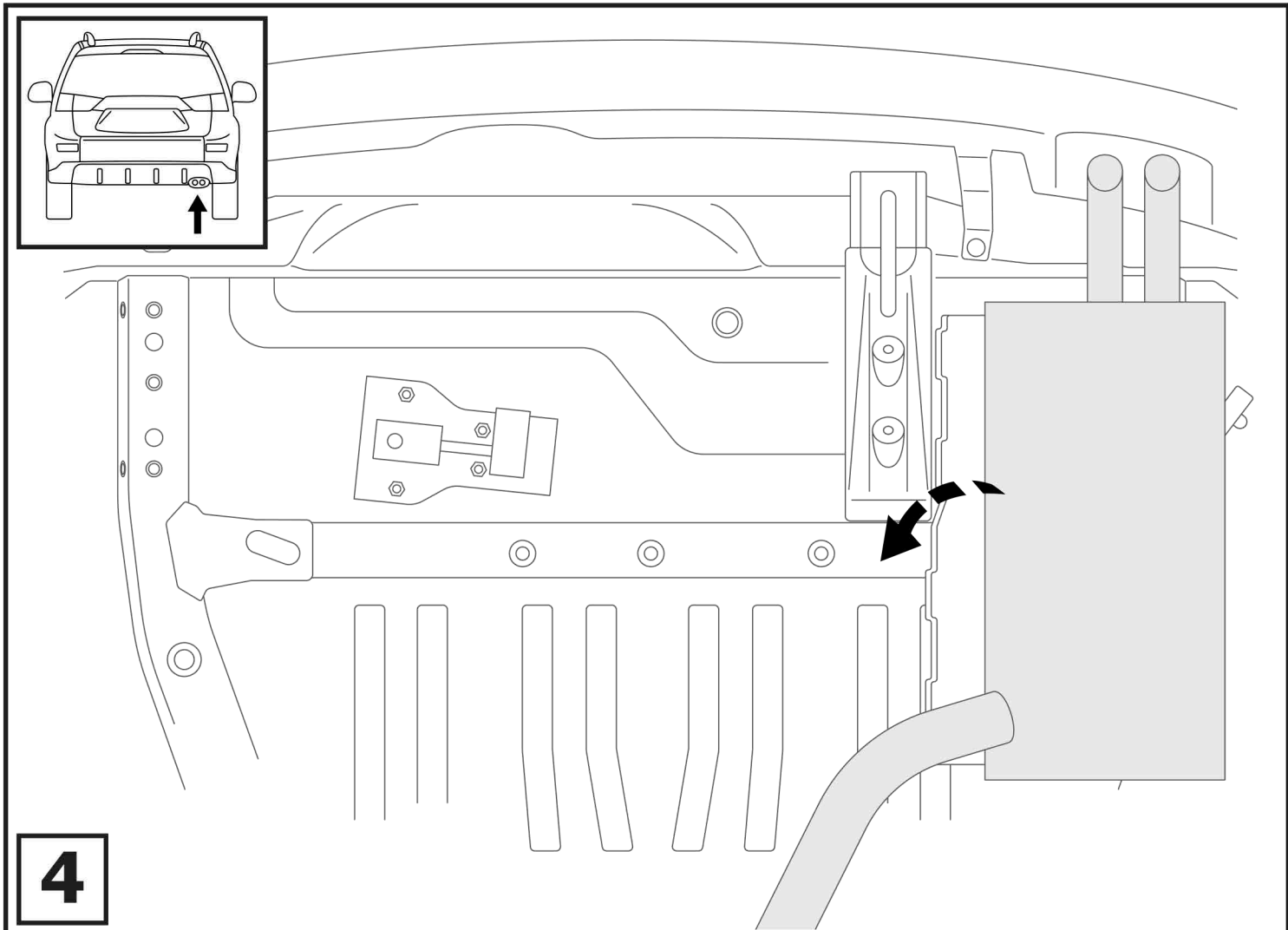

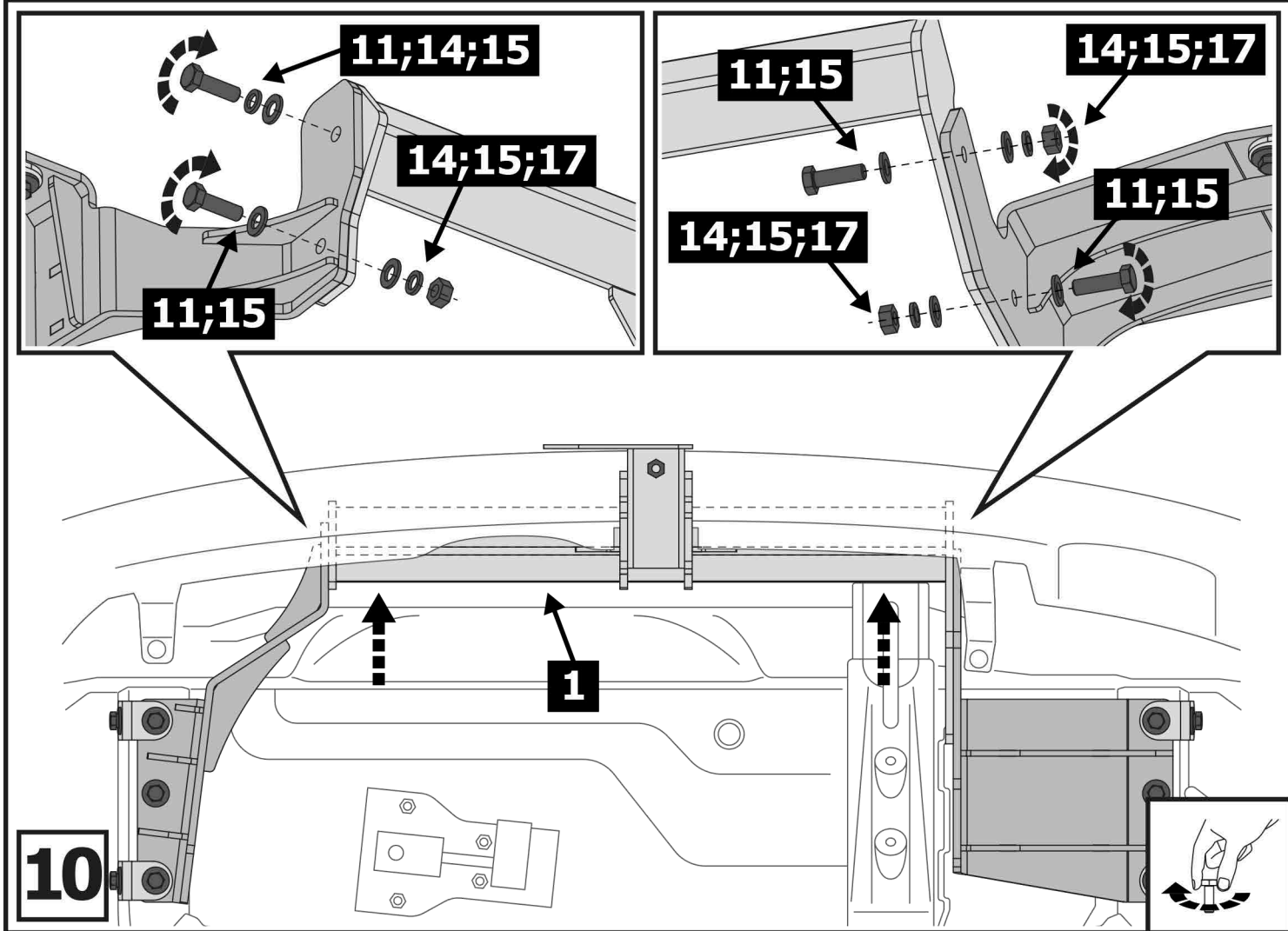
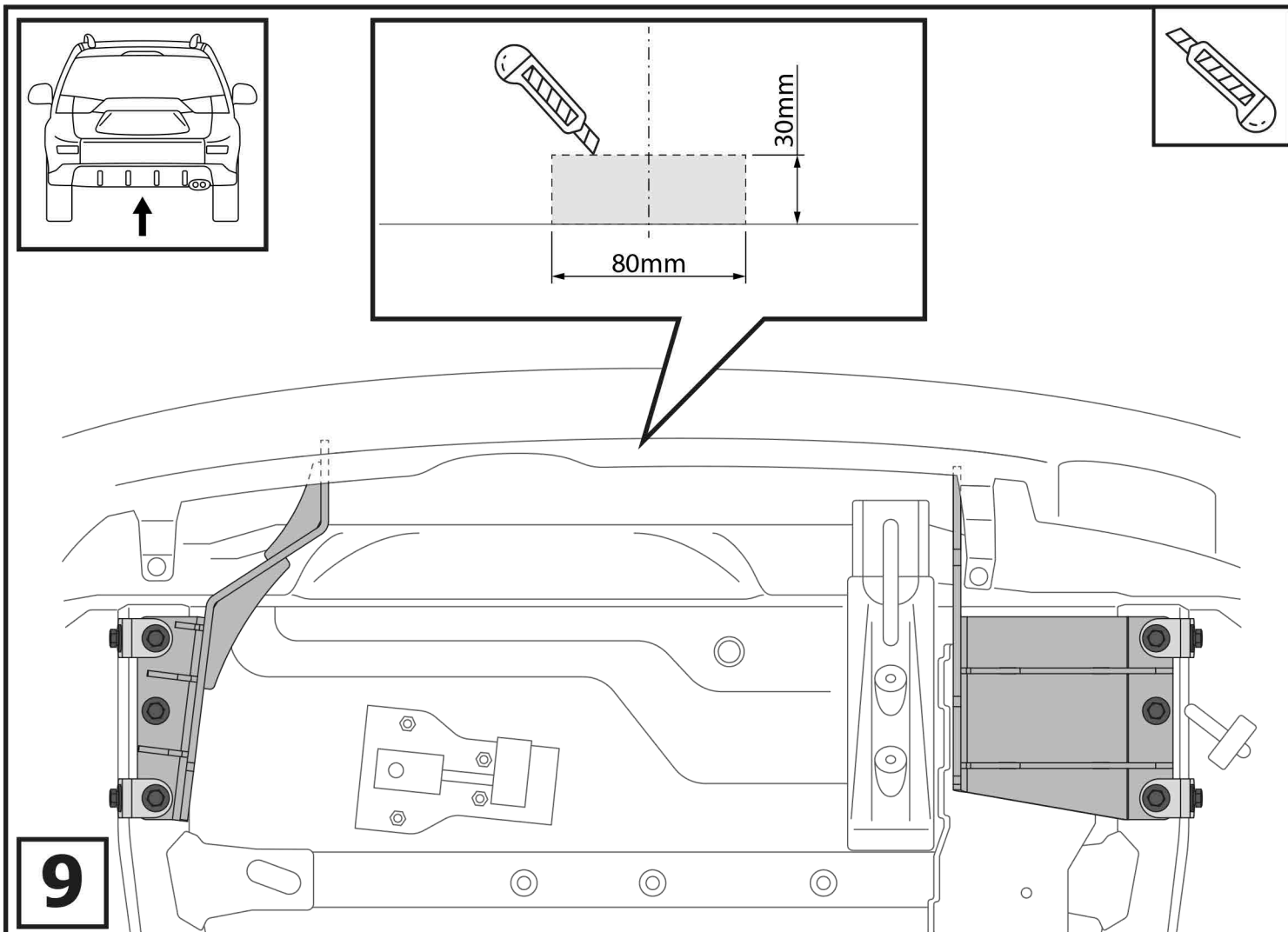

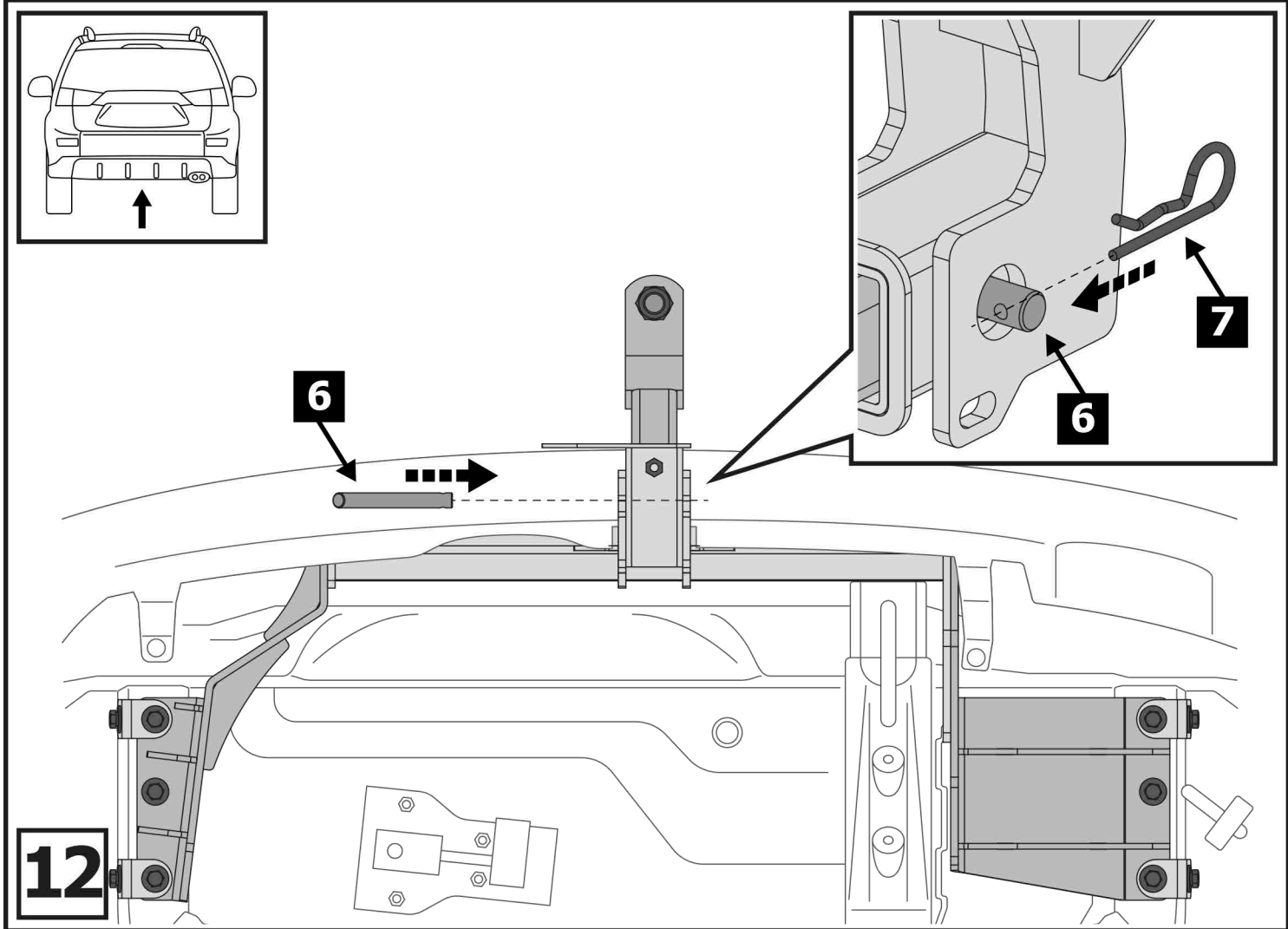
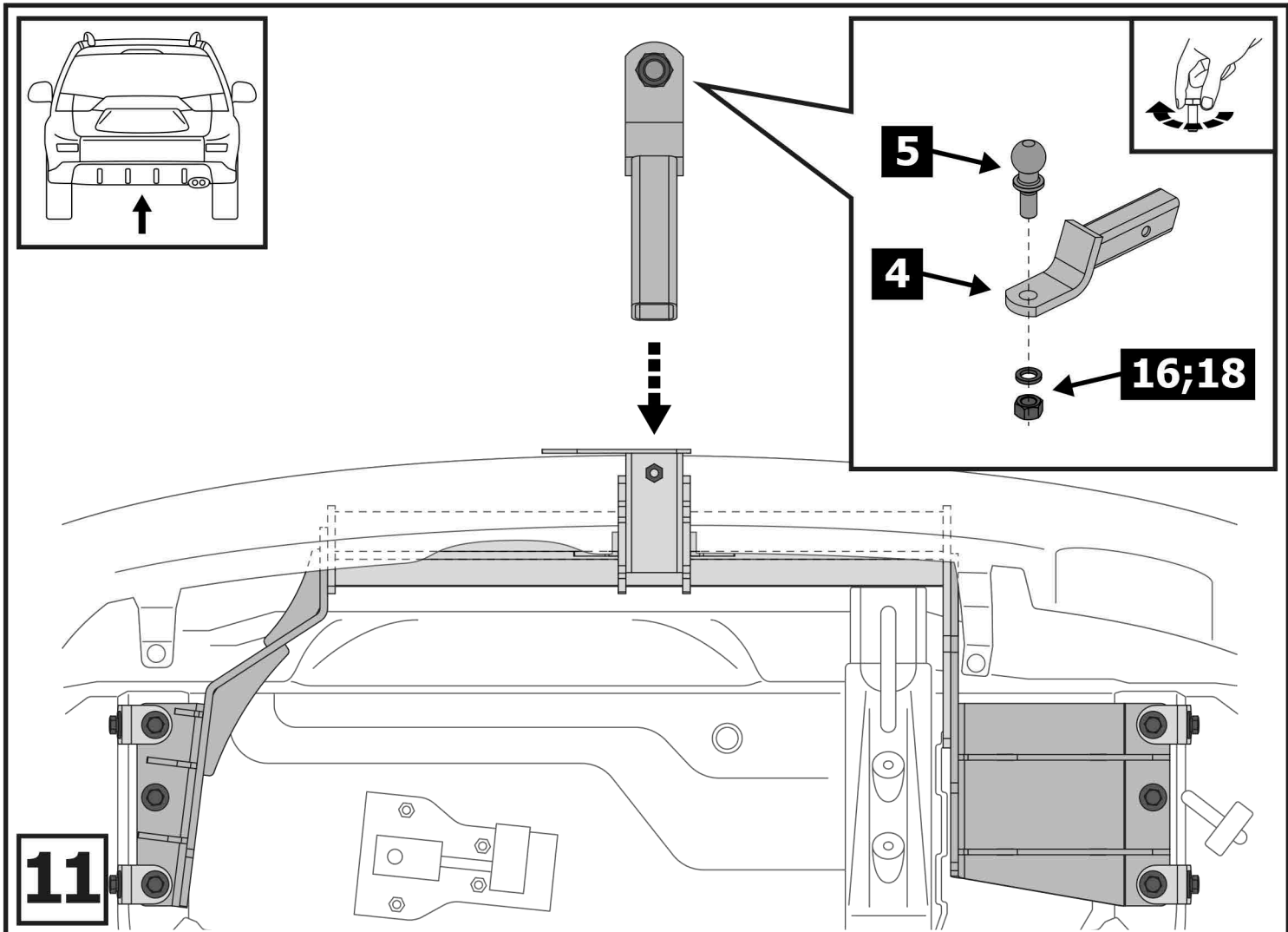

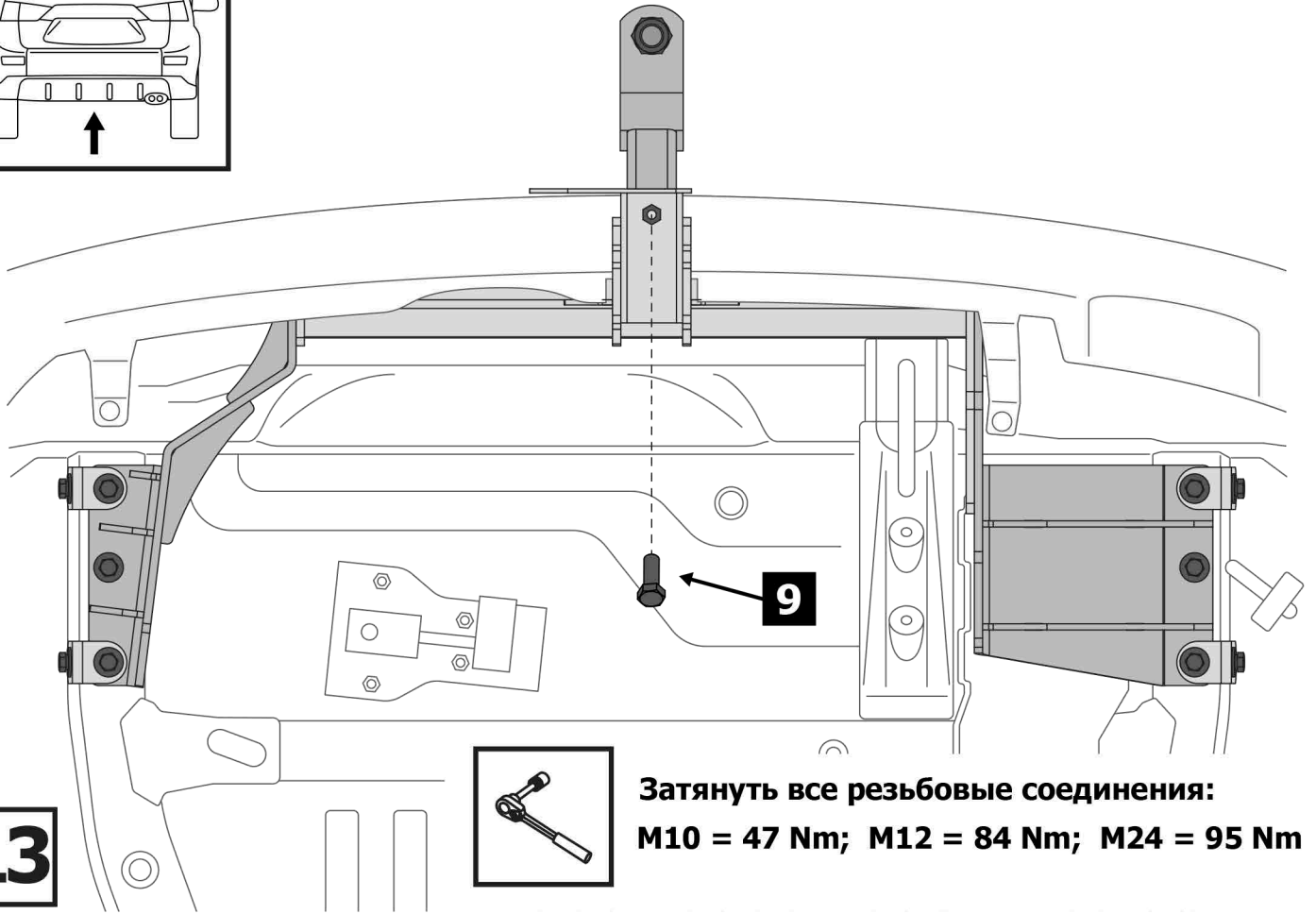
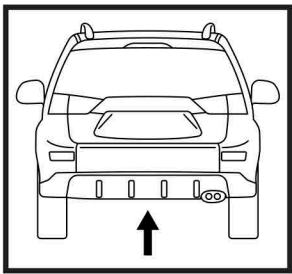

**Затянуть все резьбовые соединения:
M10 = 47 Nm; M12 = 84 Nm; M24 = 95 Nm**