

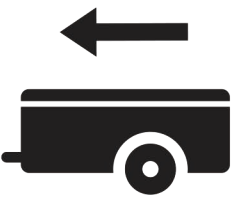



Инструкция по установке Mitsubishi L200

(2018-)

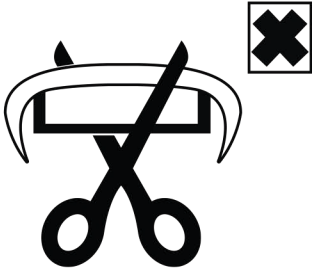

Арт.: F.4002.001

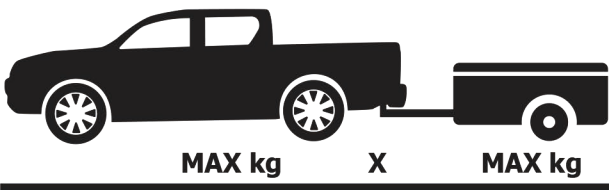
 <p>3500 kg</p>	 <p>120 kg</p>	<p>D = 15,4 kN</p>	
---	--	---------------------------	---

<p>D (kN) =</p>		<p>x 0,00981</p>
		



Вкрутить/выкрутить используя инструмент

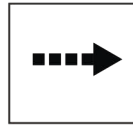

Движение

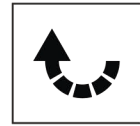

Поворот



Вкрутить/выкрутить не затягивая

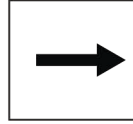





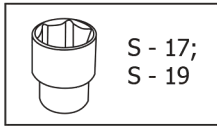
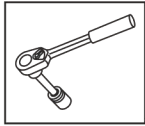

Расположение

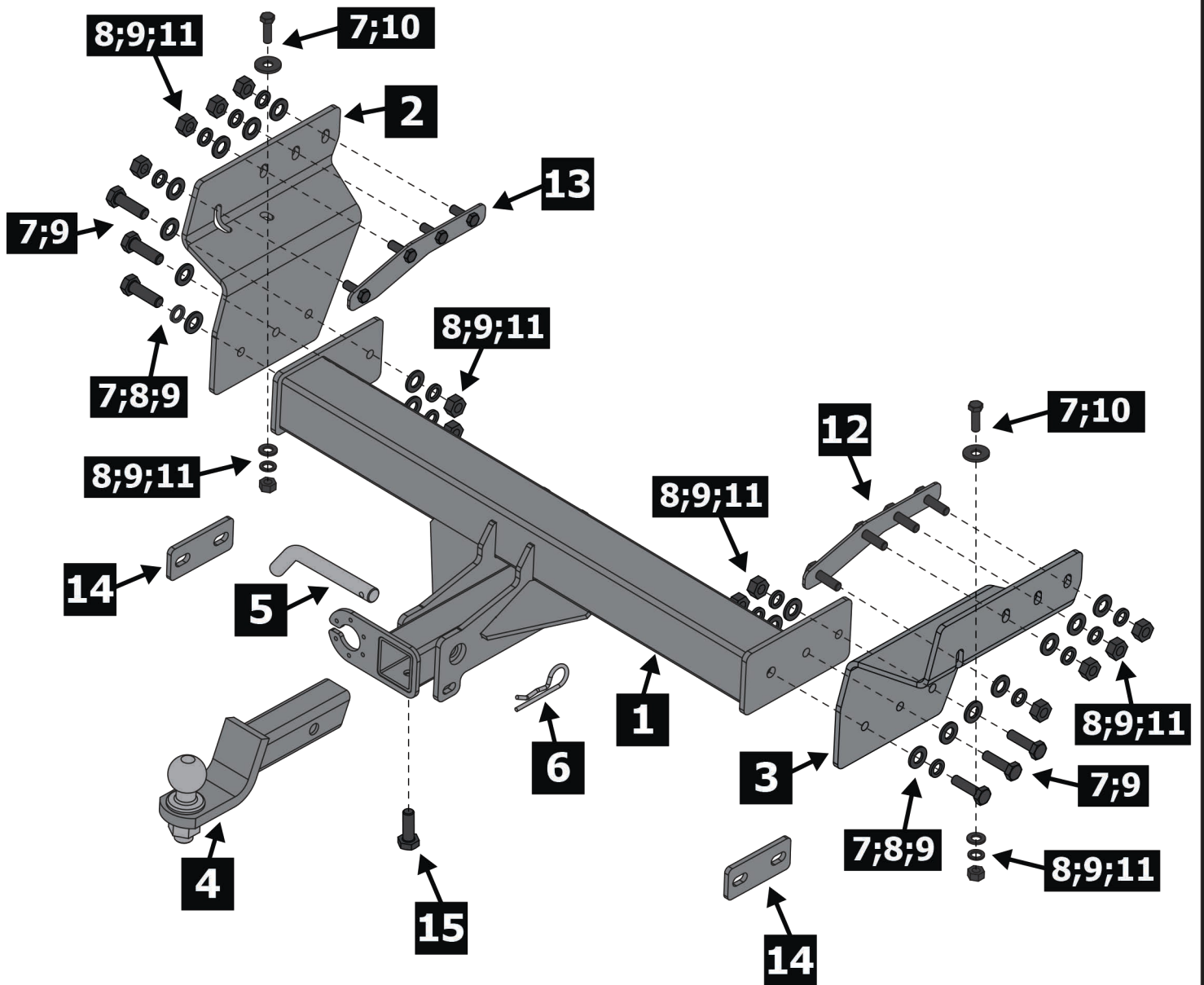
Используемый инструмент:

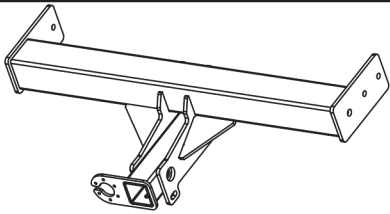
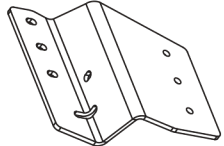
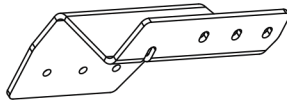
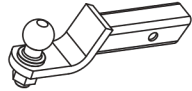

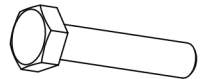
S - 17;
S - 19

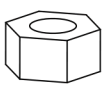
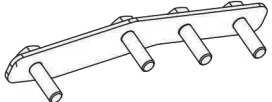
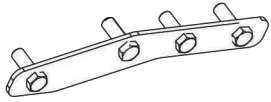
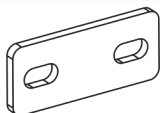

1	x1	Балка	
2	x1	Кронштейн левый	
3	x1	Кронштейн правый	
4	x1	Крюк	
5	x1	Штифт	
6	x1	Шплинт	
7	x8	M12x1,25x40	
8	x16	∅ 12	
9	x20	∅ 12	
10	x2	∅ 12	
11	x14	M12x1,25	
12	x1	Закладная пластина правая	
13	x1	Закладная пластина левая	
14	x2	Проставка	
15	x1	M10x20	