

Инструкция по установке

RENAULT LOGAN

(2005-2015)



Арт.: F.4713.001

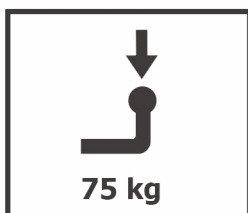
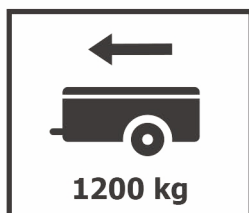

$D = 6,7 \text{ kN}$

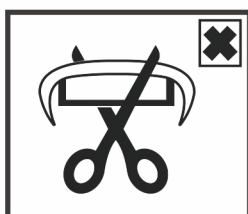

$$D \text{ (kN)} = \frac{\text{MAX kg} \times \text{MAX kg}}{\phantom{\text{MAX kg} \times \text{MAX kg}}} \times 0,00981$$
$$D \text{ (kN)} = (\text{MAX kg} + \text{MAX kg}) \times 0,00981$$

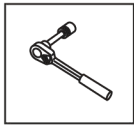

Вкрутить/выкрутить используя инструмент

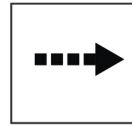

Движение

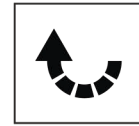

Поворот



Вкрутить/выкрутить не затягивая

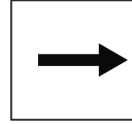





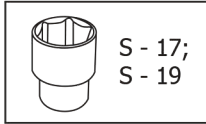
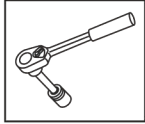



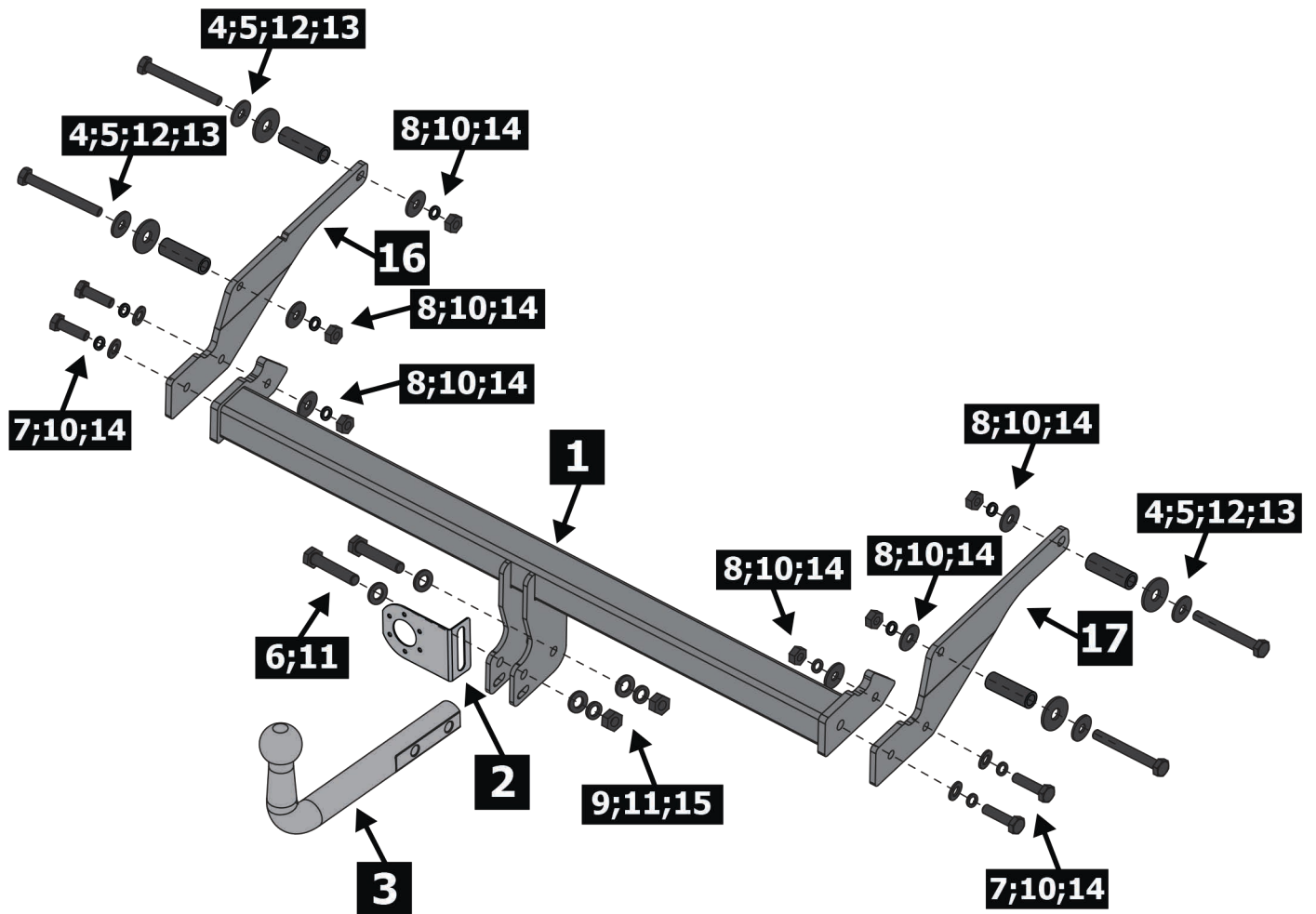

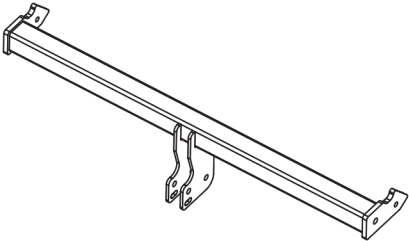
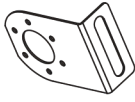
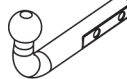

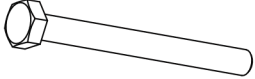
Расположение

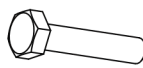
Используемый инструмент:

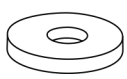

S - 17;
S - 19

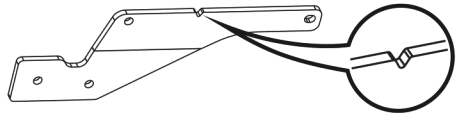
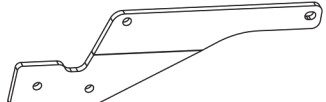

1	x1	Балка	
2	x1	Подрозетник	
3	x1	Крюк	
4	x4	Втулка	
5	x4	M10x90	
6	x2	M12x1.25x70	
7	x4	M10x40	
8	x6	M10	
9	x2	∅ 12	
10	x8	∅ 10	
11	x4	∅ 12	
12	x4	∅ 10	
13	x4	∅ 12	
14	x10	∅ 10	
15	x2	M12x1.25	
16	x1	Кронштейн левый	
17	x1	Кронштейн правый	

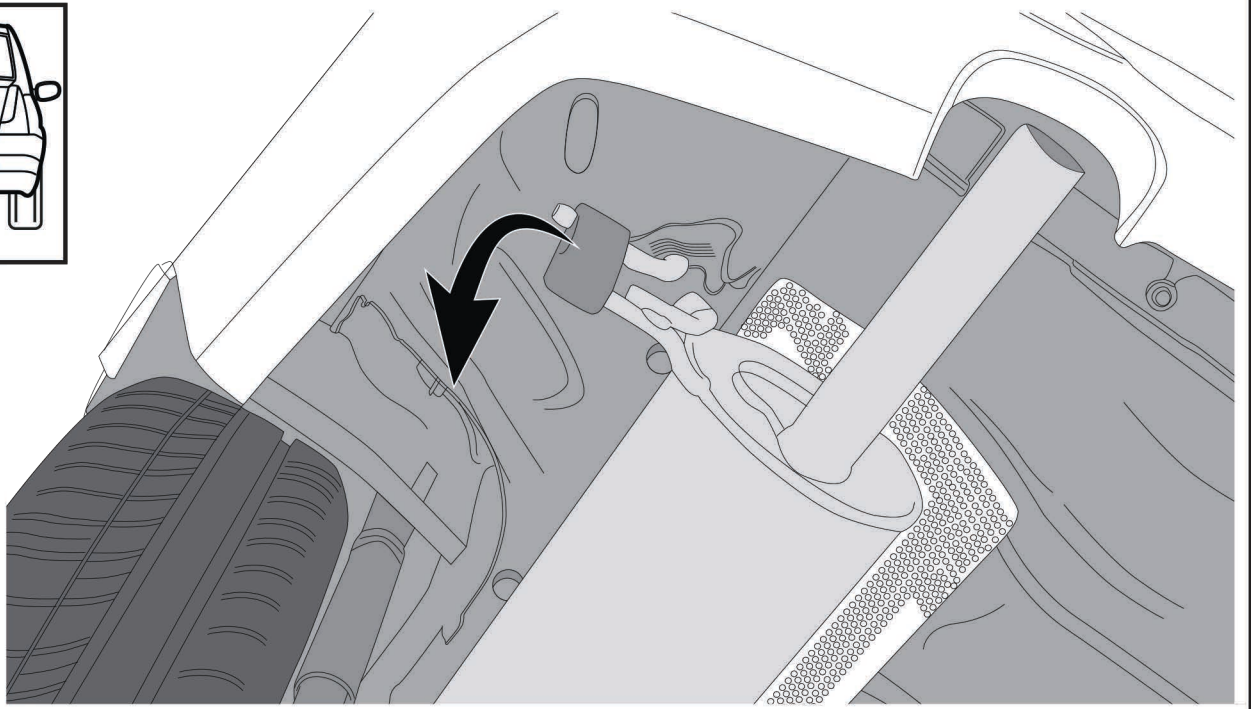
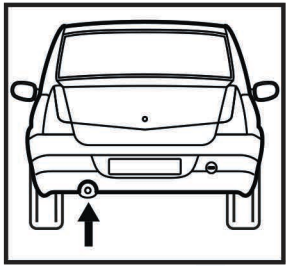

1

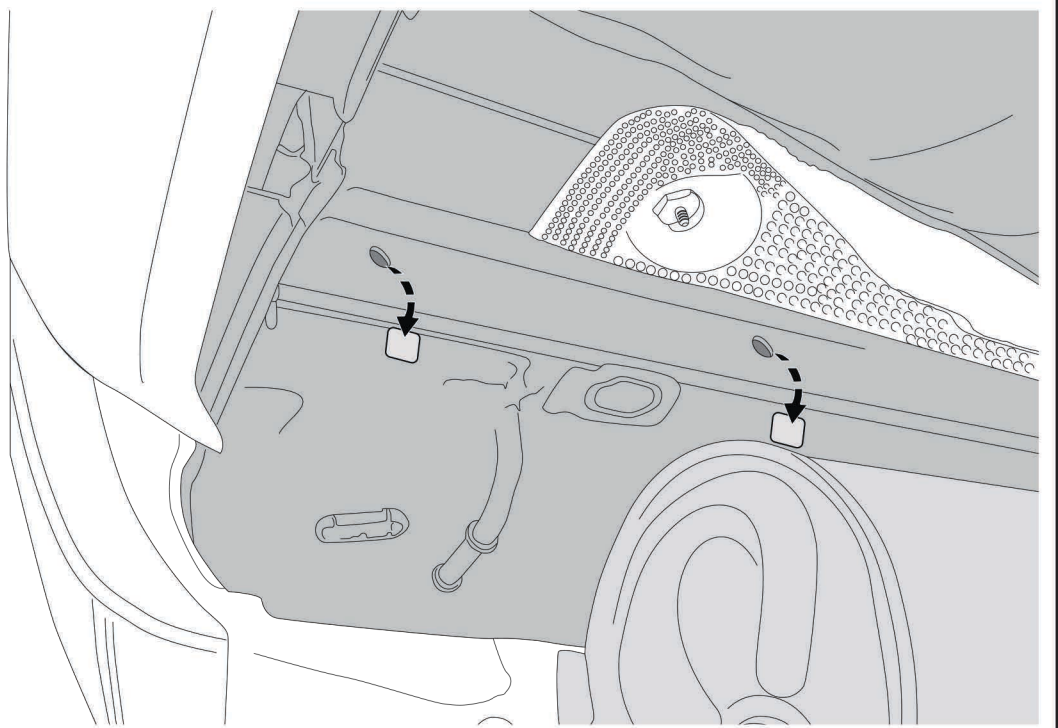
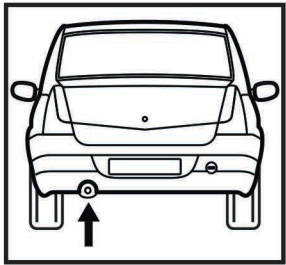

2

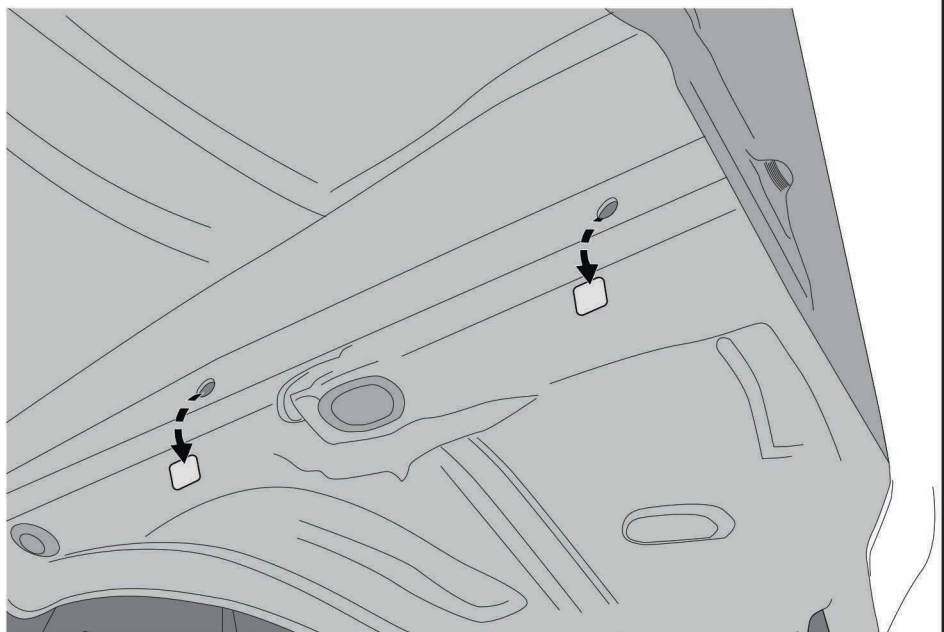
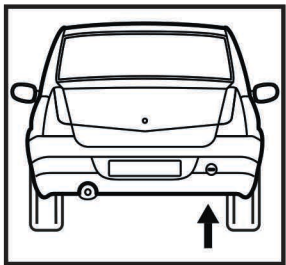

3

