

Инструкция по установке
RENAULT SANDERO
(2009-2014)

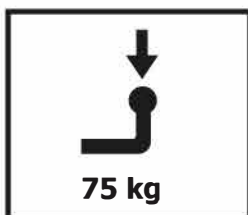

Арт.: F.4714.001

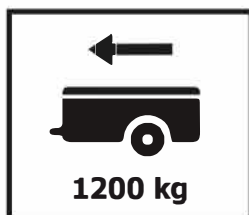

$D = 6,58 \text{ kN}$

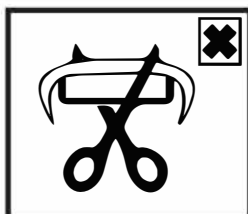

$$D \text{ (kN)} = \frac{\text{MAX kg} \times \text{MAX kg}}{\text{MAX kg} + \text{MAX kg}} \times 0,00981$$



Вкрутить/выкрутить используя инструмент

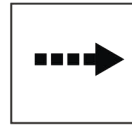

Движение

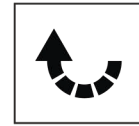

Поворот



Вкрутить/выкрутить не затягивая

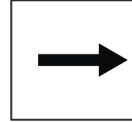





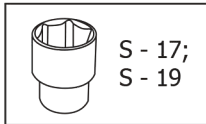
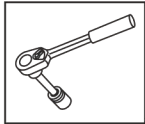



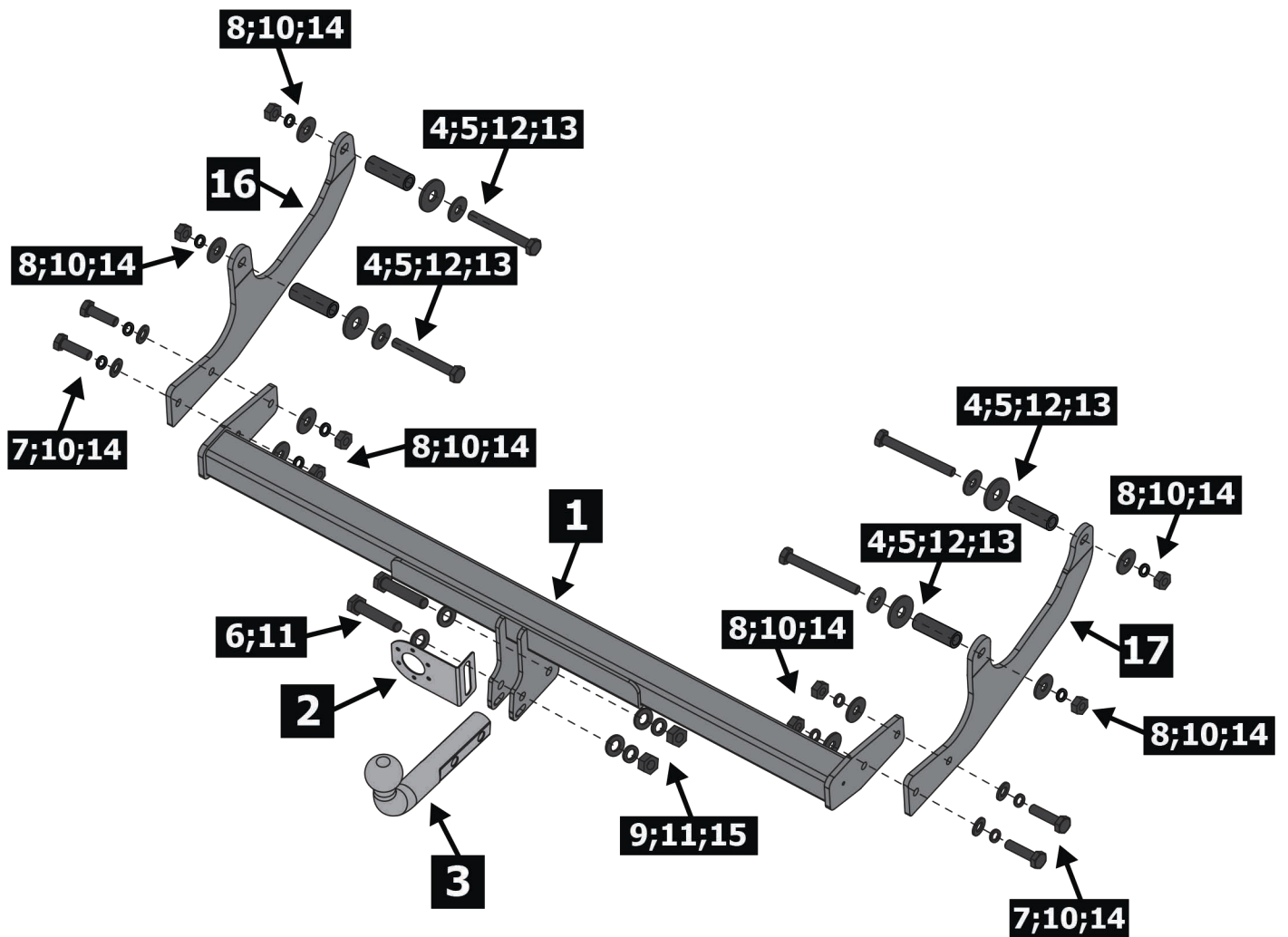

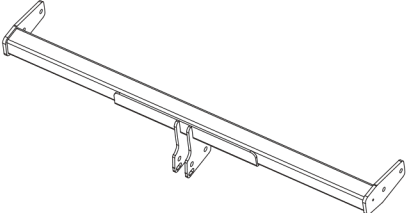
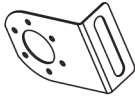
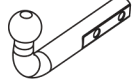

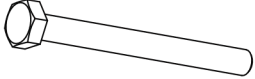

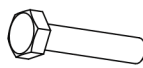
Расположение

Используемый инструмент:

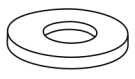
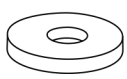

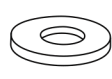
S - 17;
S - 19



1	x1	Балка	
2	x1	Подрозетник	
3	x1	Крюк	
4	x4	Втулка	
5	x4	M10x90	
6	x2	M12x1.25x70	
7	x4	M10x35	
8	x8	M10	
9	x2	∅ 12	
10	x8	∅ 10	
11	x4	∅ 12	
12	x8	∅ 10	
13	x4	∅ 12	
14	x10	∅ 10	
15	x2	M12x1.25	
16	x1	Кронштейн левый	
17	x1	Кронштейн правый	

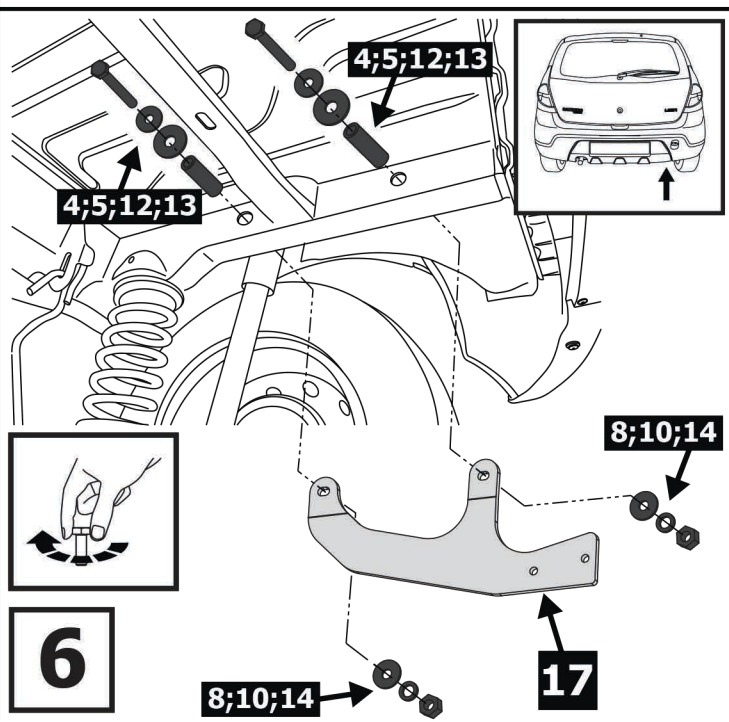
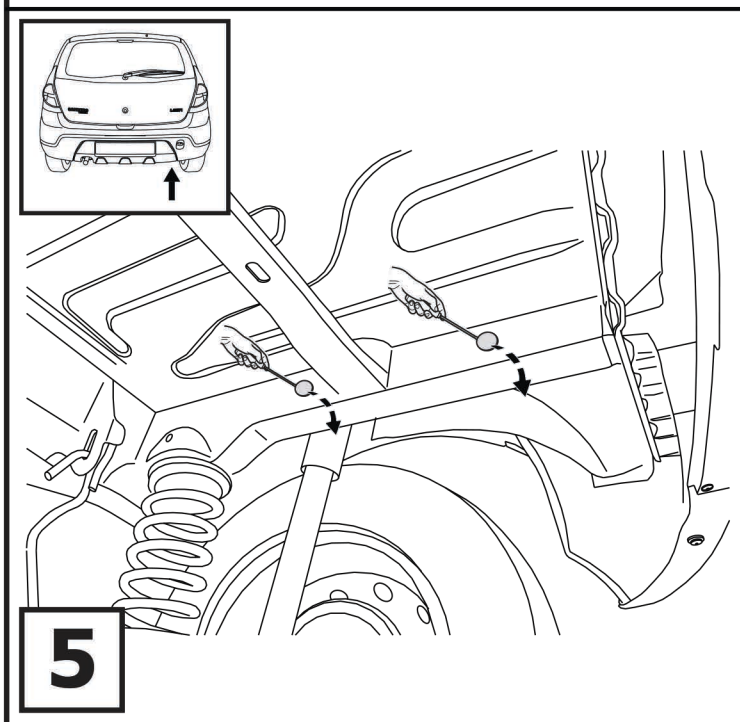
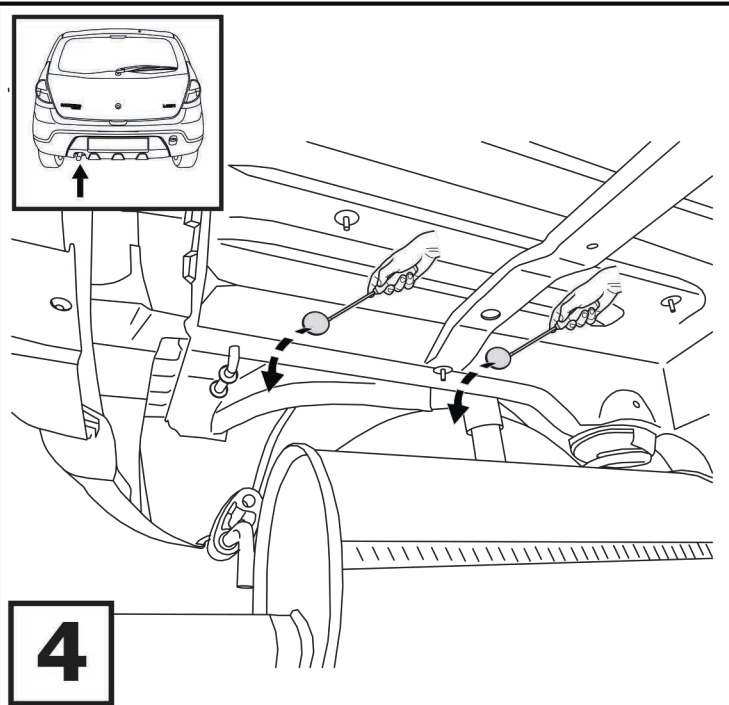
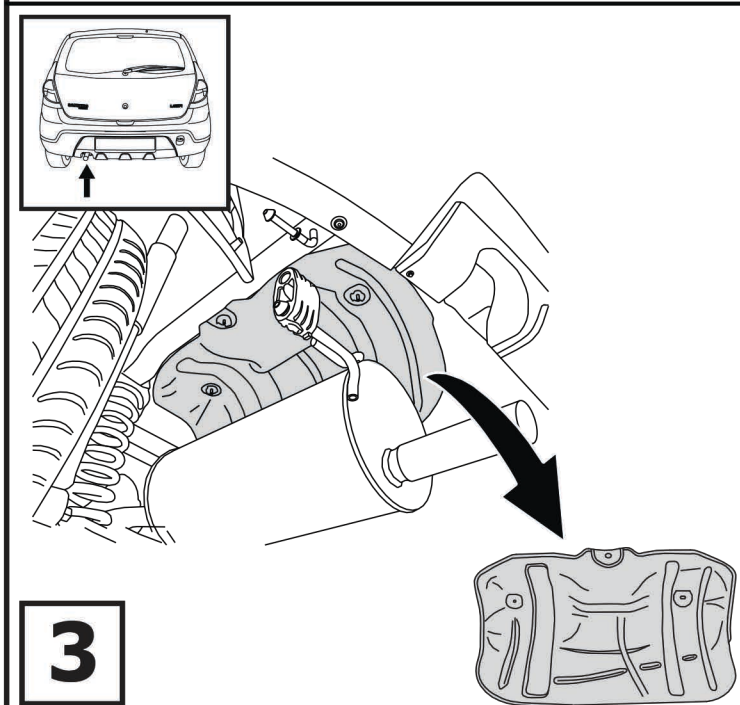
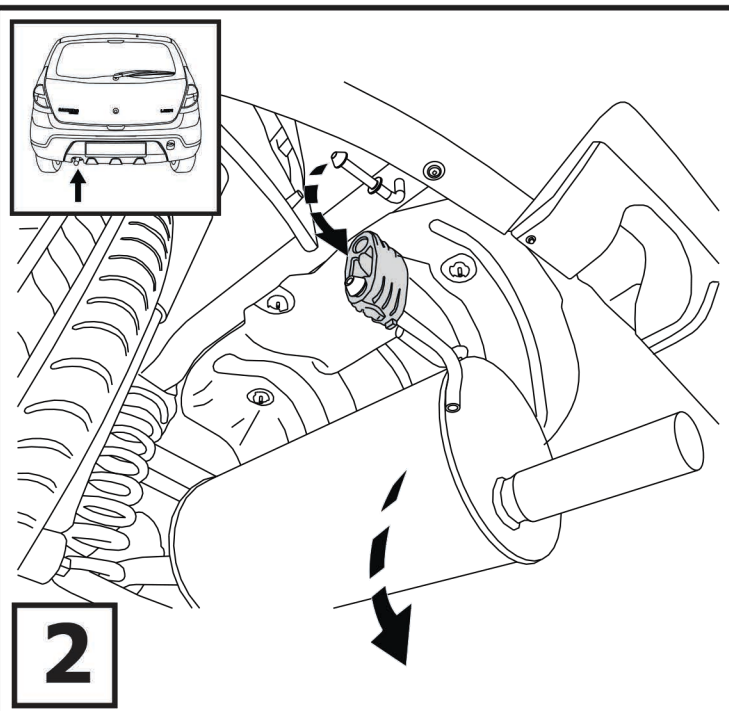
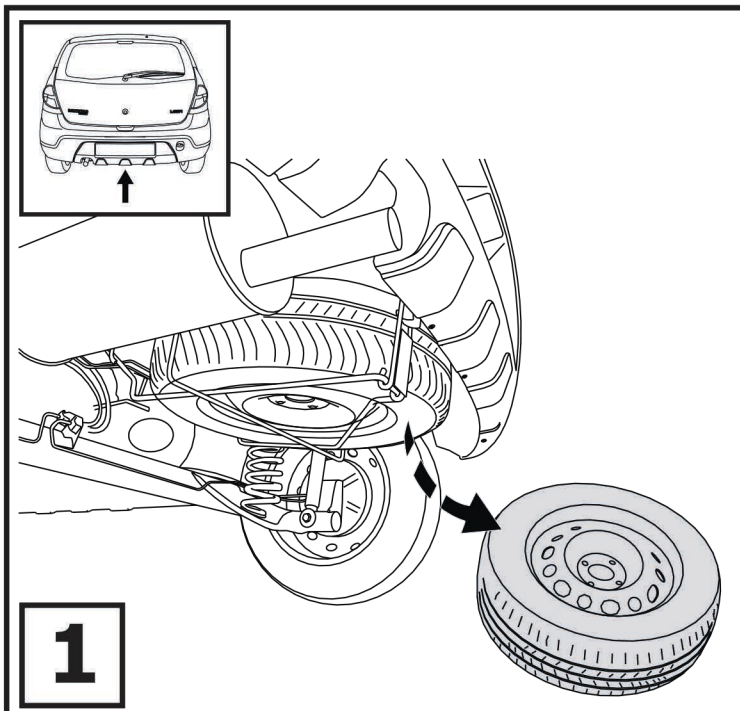

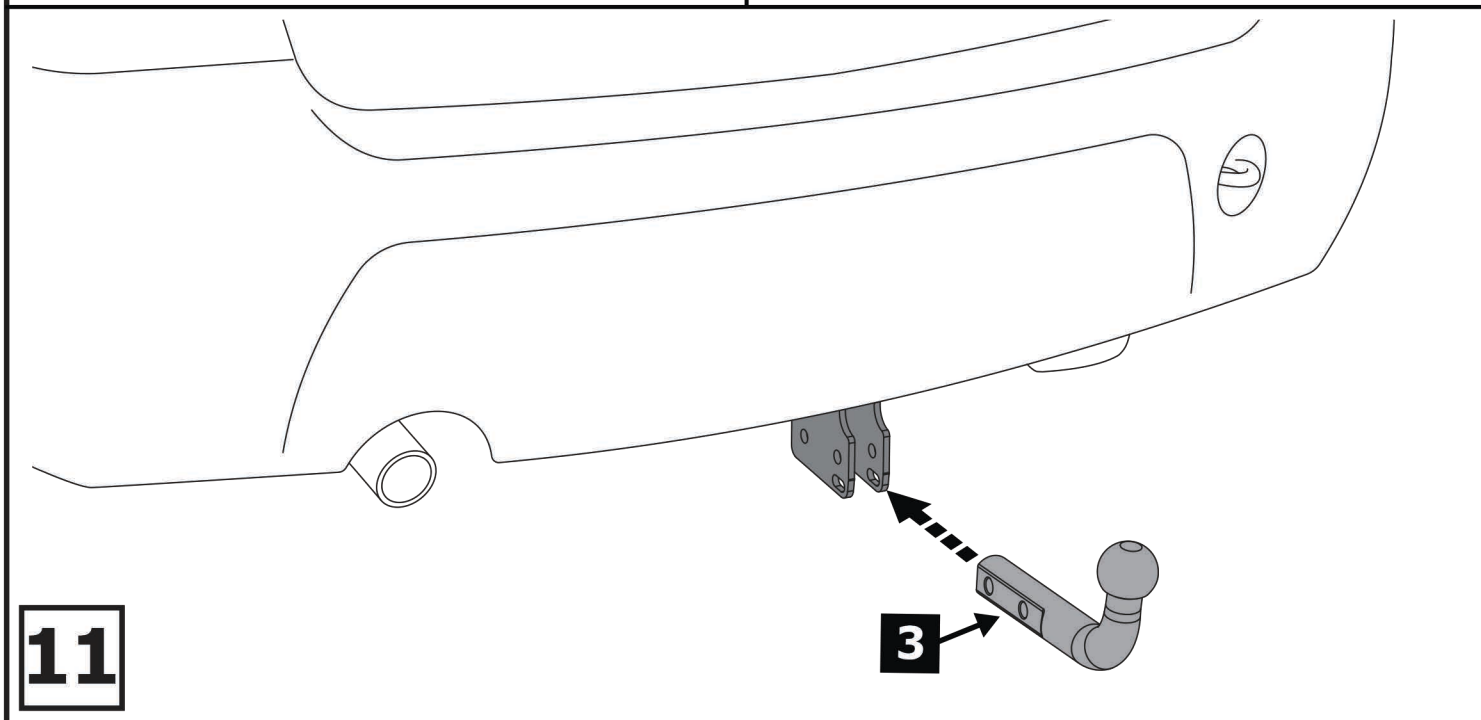
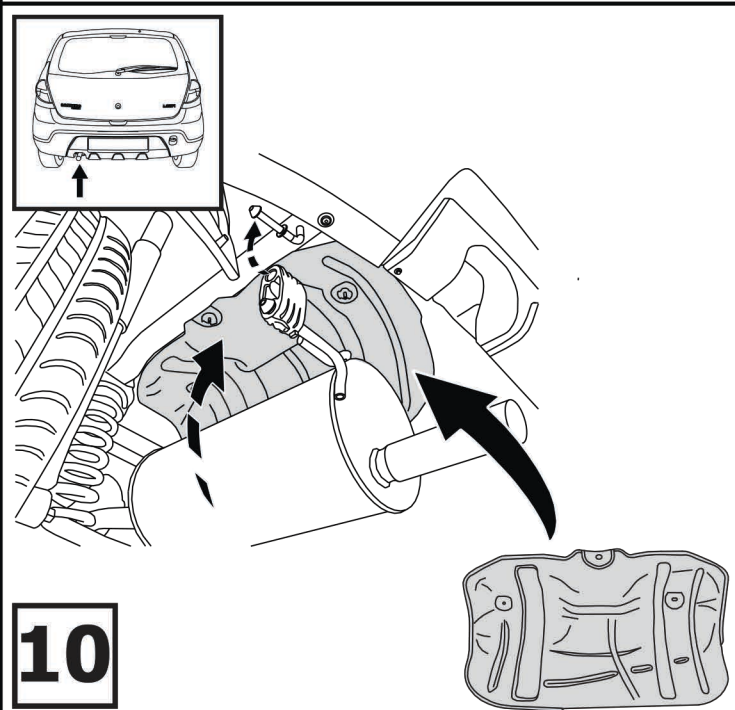
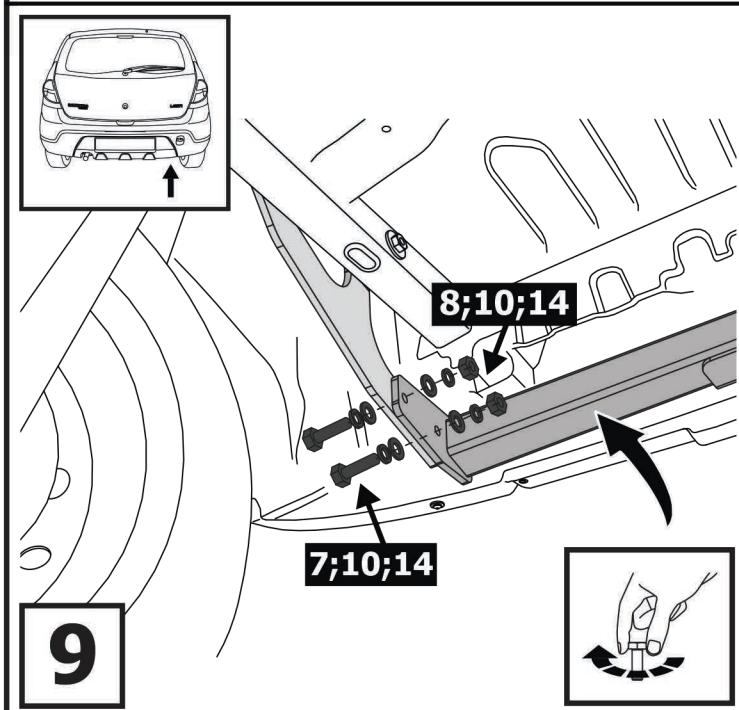
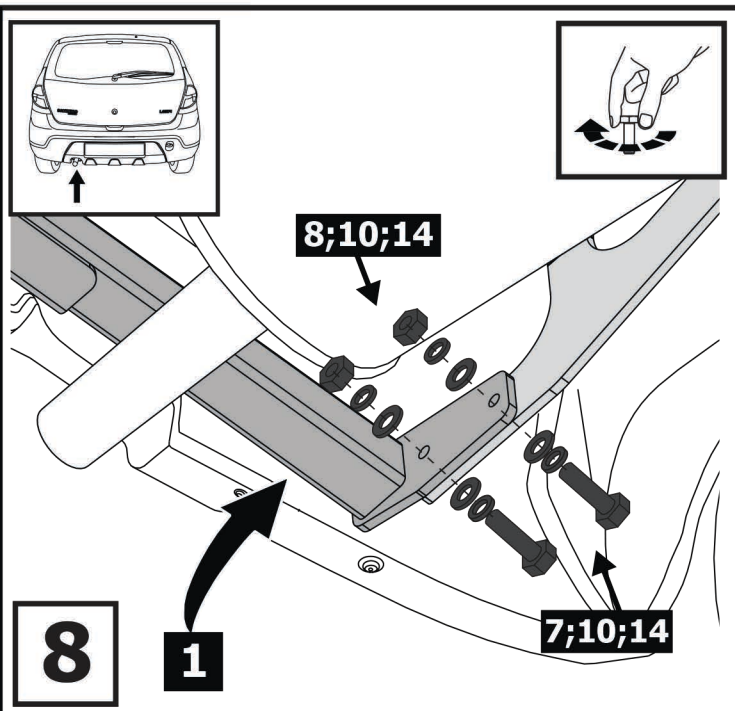
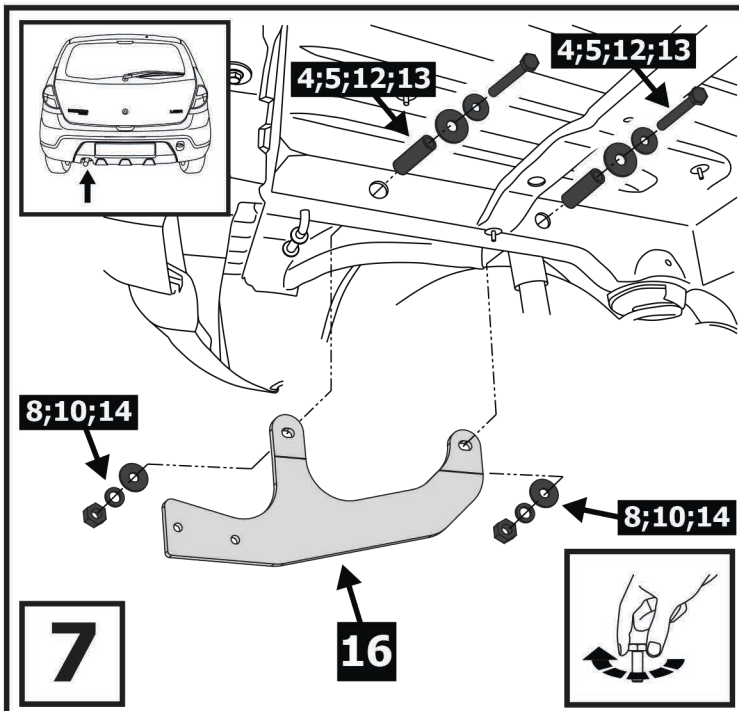

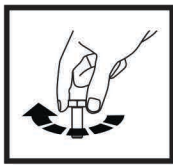

12

6;11

2

9;11;15

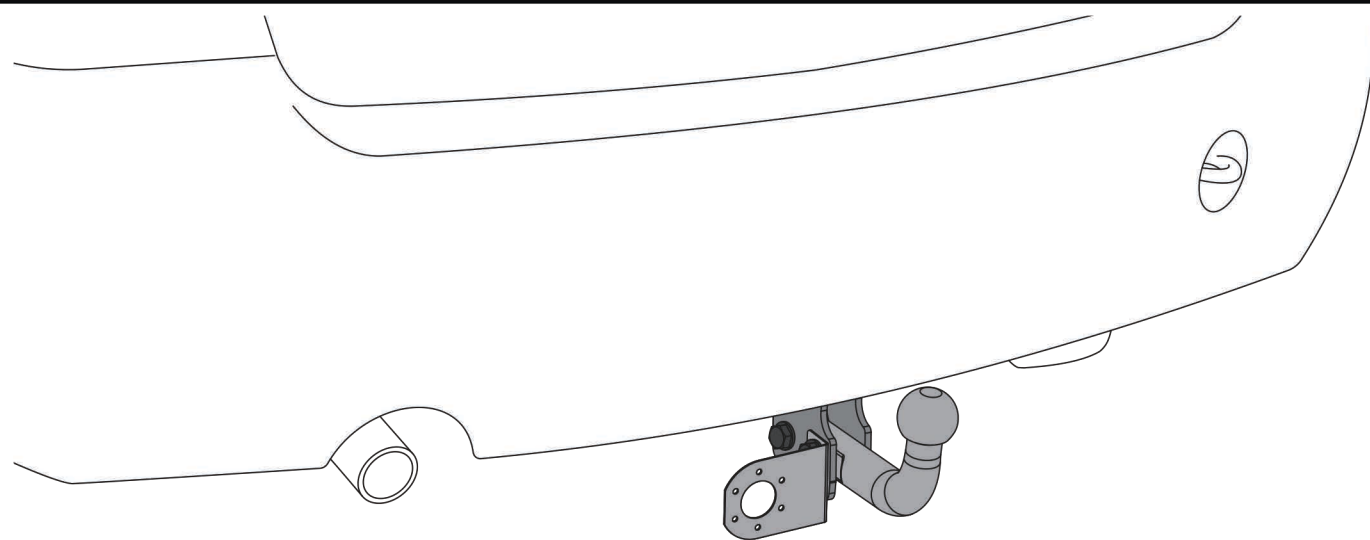

13



Затянуть все резьбовые соединения
M10 = 47 Nm M12 = 84 Nm