

Инструкция по установке

LADA 4x4

(1995-)



Арт.: F.6014.004

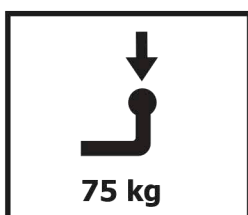
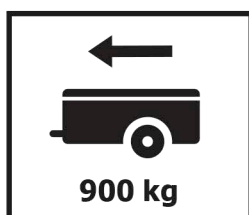

D = 5,94 kN

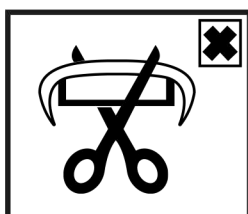

$$D \text{ (kN)} = \frac{\text{MAX kg} \times \text{MAX kg}}{\text{MAX kg} + \text{MAX kg}} \times 0,00981$$

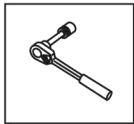

Вкрутить/выкрутить используя инструмент

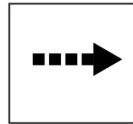

Движение

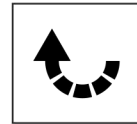

Поворот



Вкрутить/выкрутить не затягивая

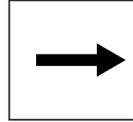





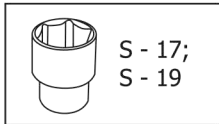
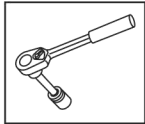

Расположение

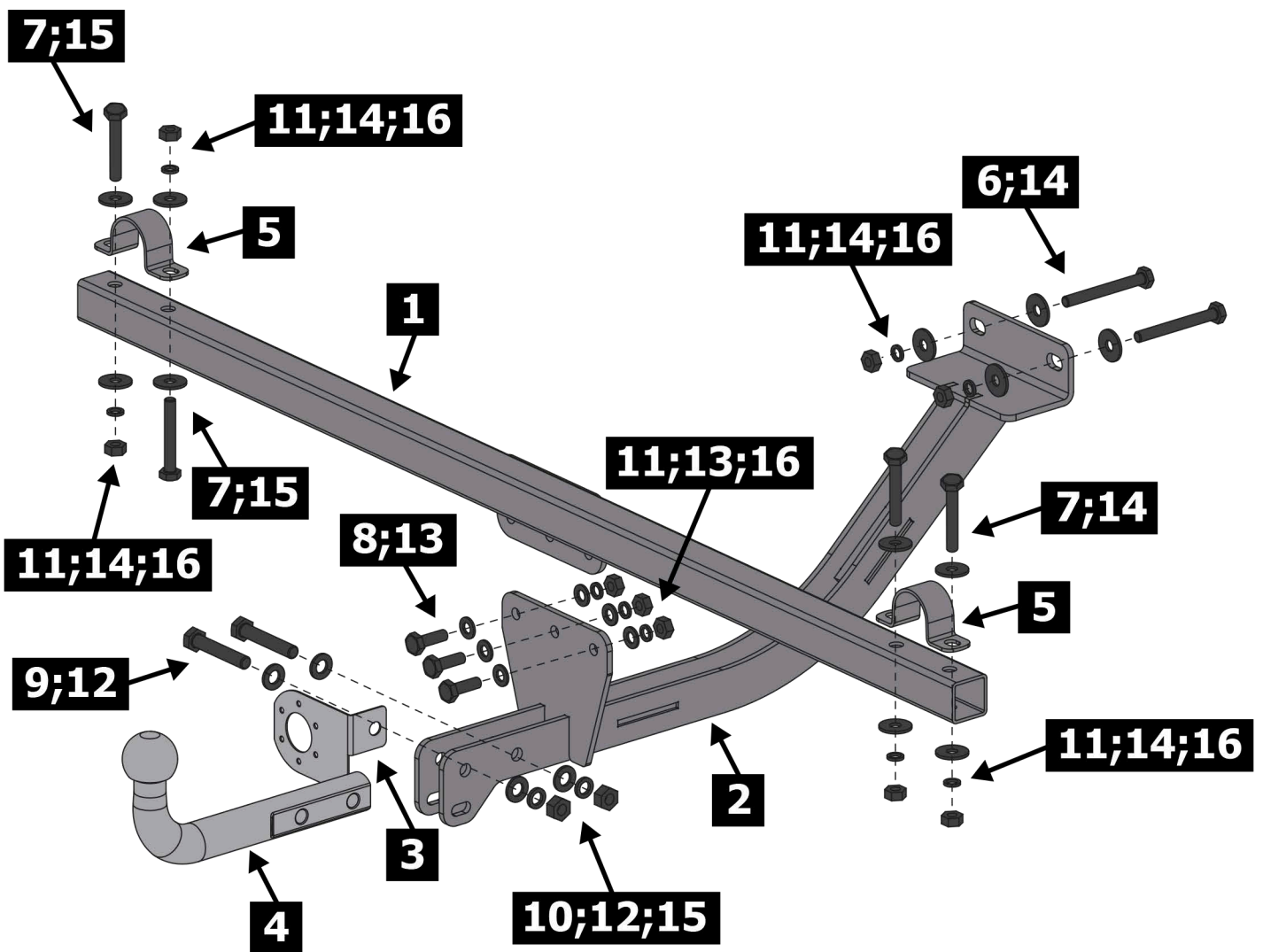
Используемый инструмент:

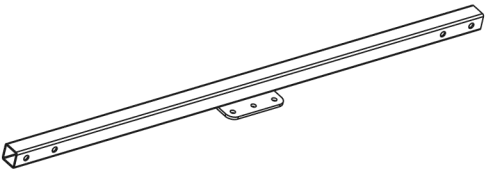
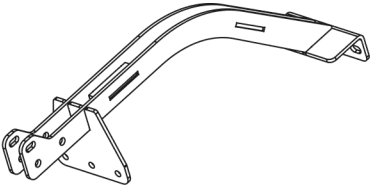
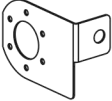
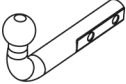
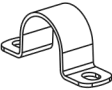
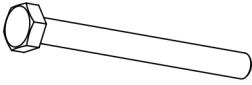
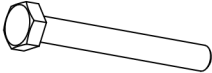
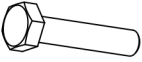
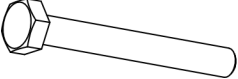

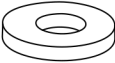
S - 17;
S - 19



1	x1	Балка	
2	x1	Кронштейн	
3	x1	Подрозетник	
4	x1	Крюк	
5	x2	Скоба	
6	x2	M10x90	
7	x4	M10x70	
8	x3	M10x35	
9	x2	M12x70	
10	x2	∅ 12	
11	x9	∅ 10	
12	x4	∅ 12	
13	x6	∅ 10	
14	x12	∅ 10	
15	x2	M12	
16	x9	M10	

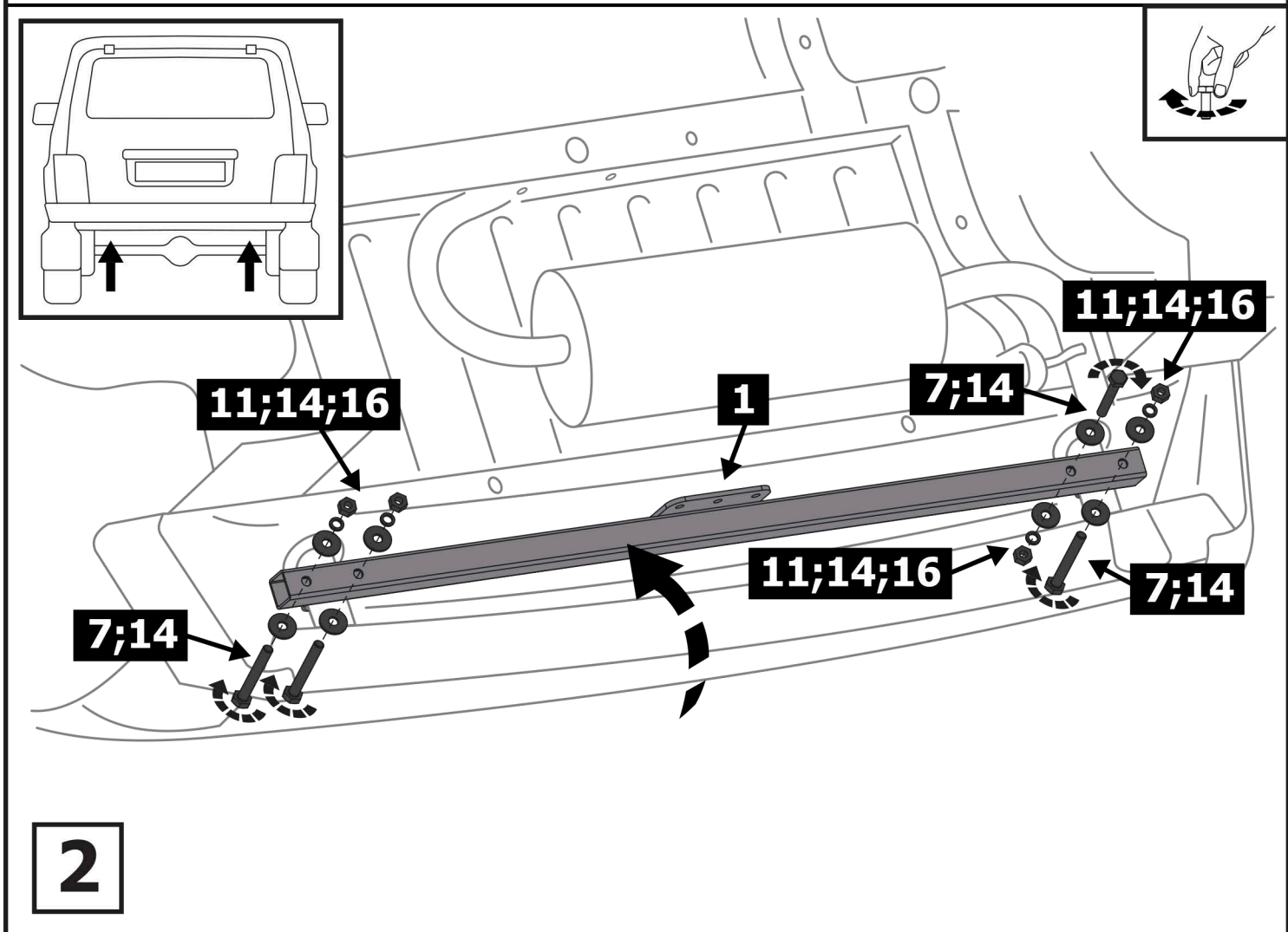
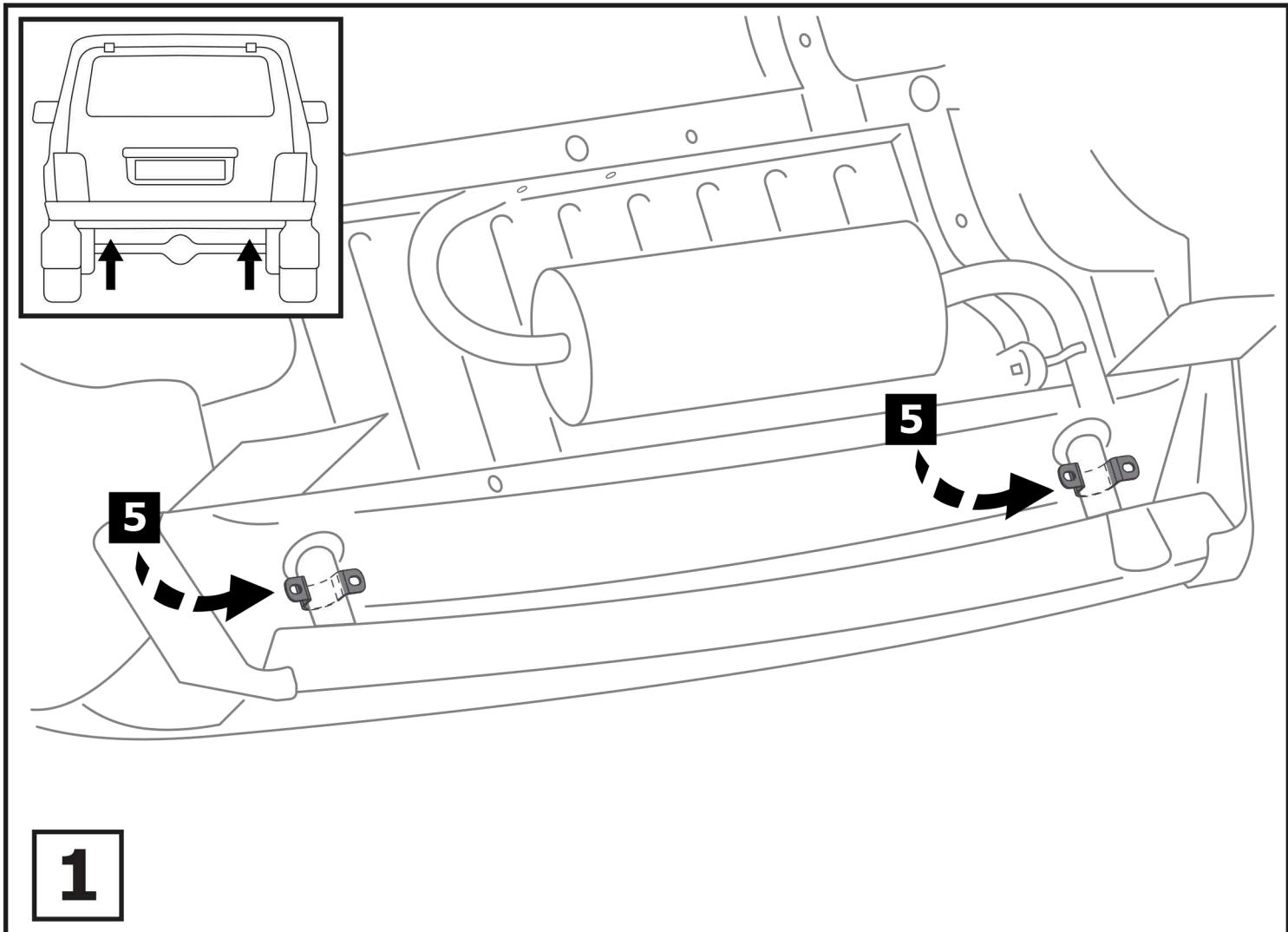

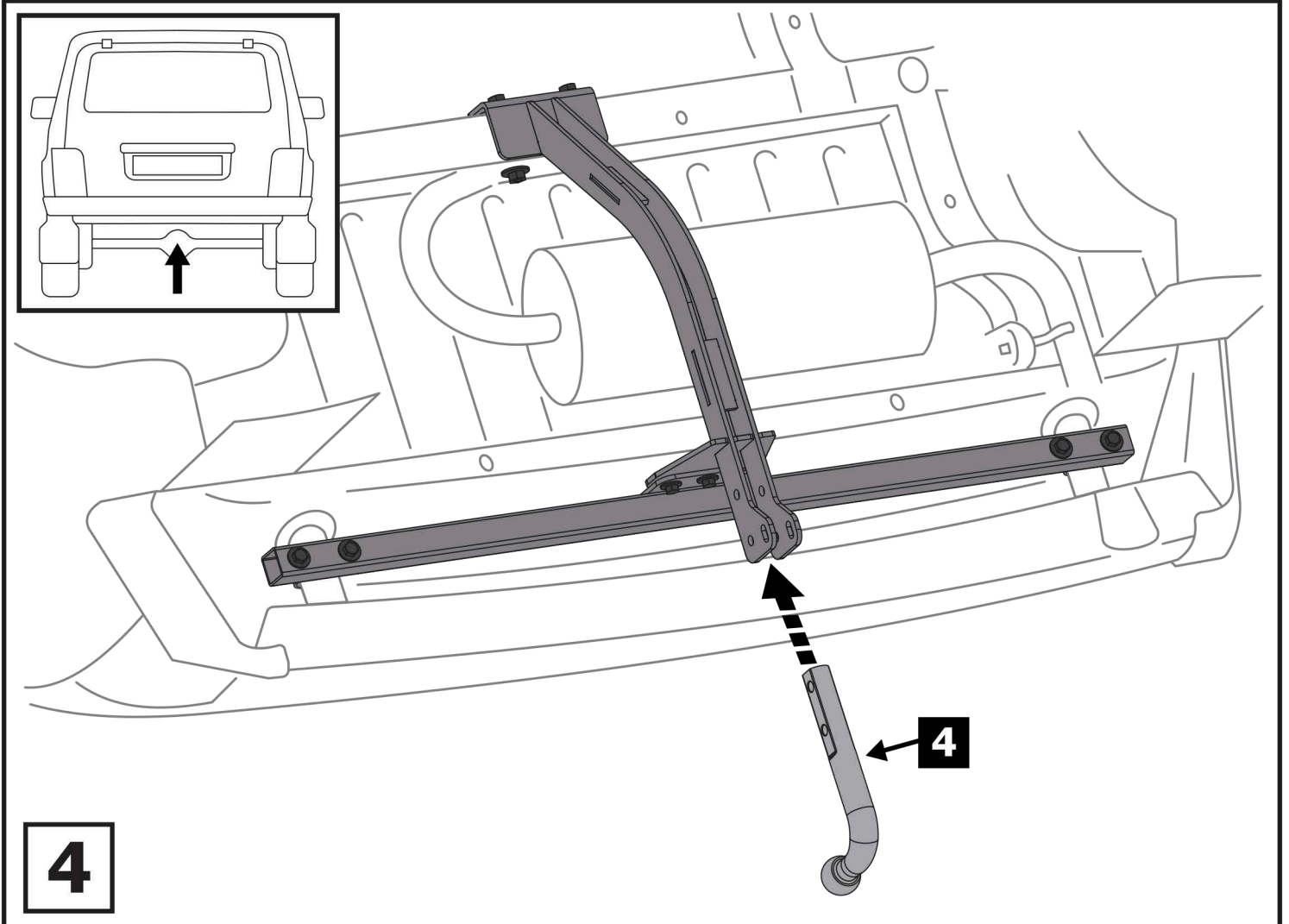
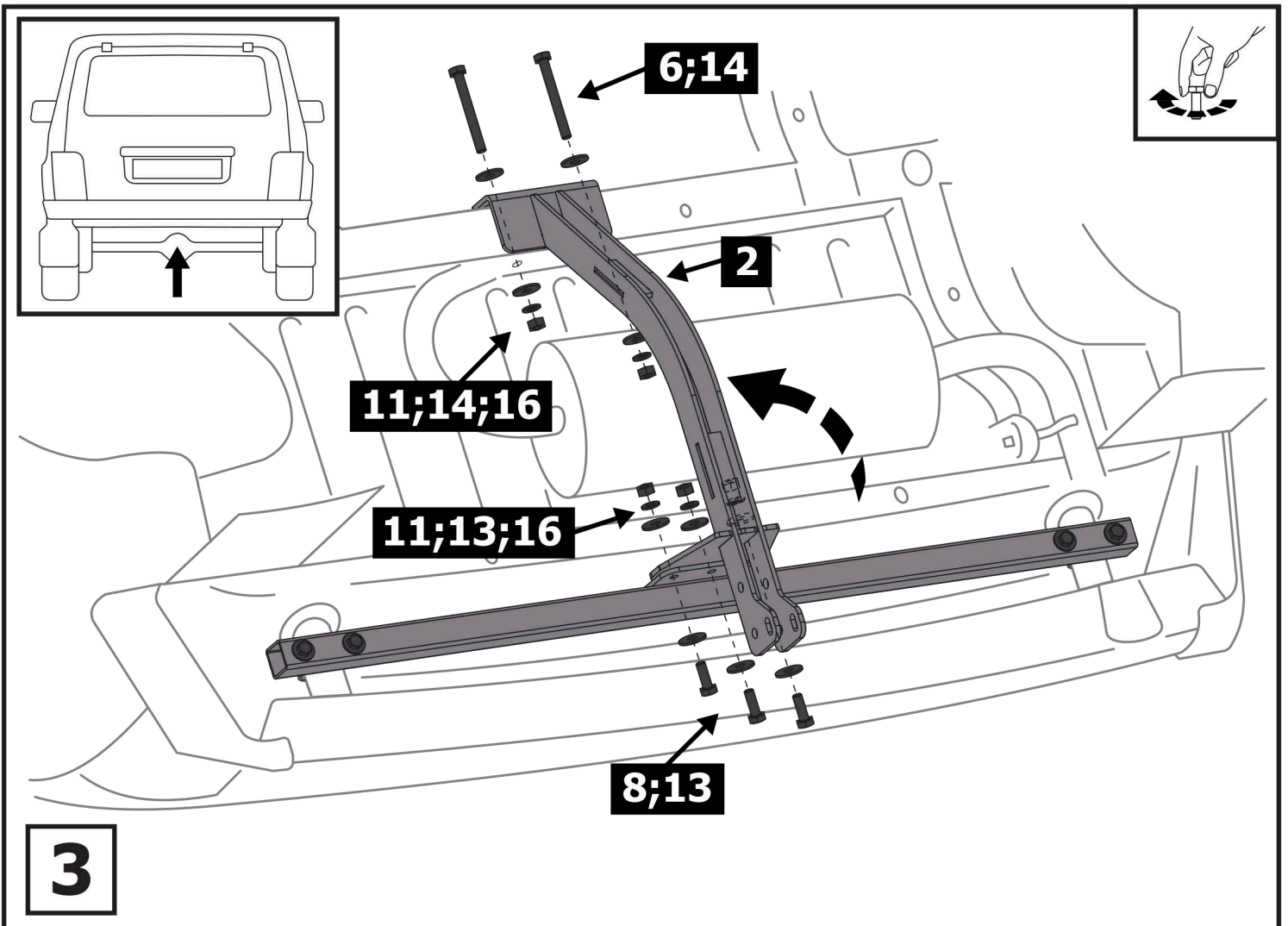

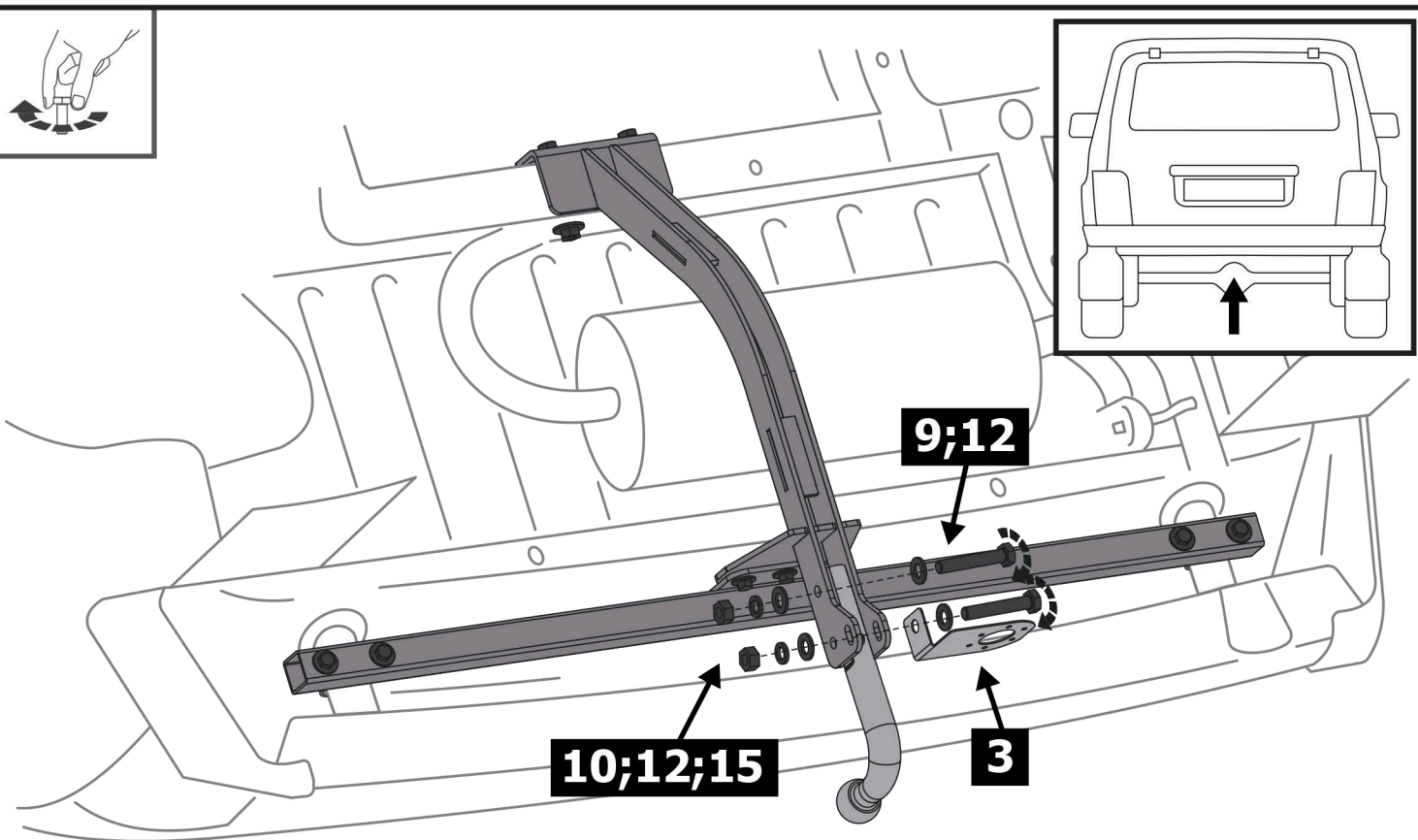
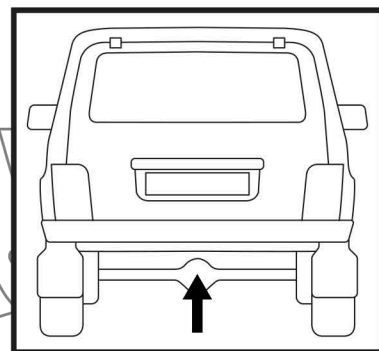
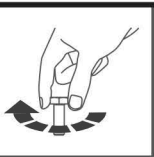

5

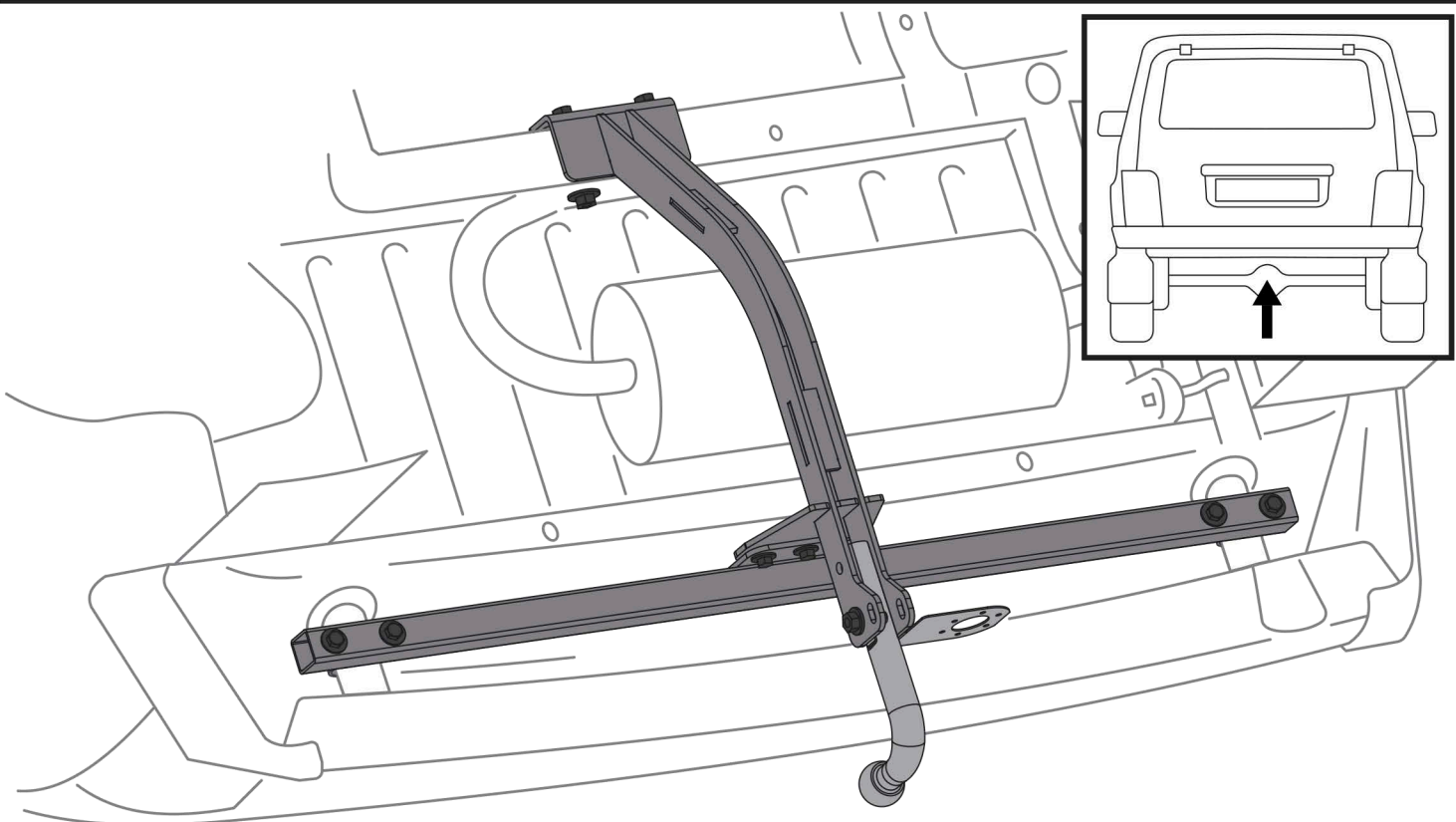
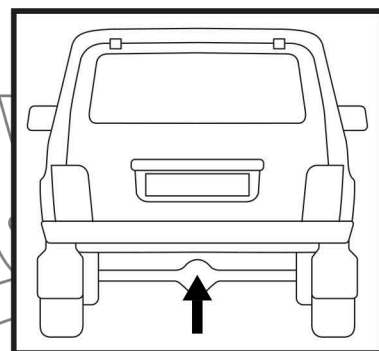

6

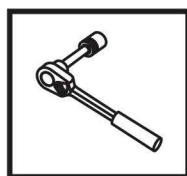

Затянуть все резьбовые соединения
M10 = 47 Nm M12 = 81 Nm