

Инструкция по установке **CHEVROLET NIVA**

(2002-2020)

LADA NIVA

(2020-2021)





LADA NIVA TRAVEL

(2021-)



Арт.: F.6016.004

Тип шара - «Е»

 1200 kg	 75 kg	 $D \text{ (kN)} = \frac{\text{MAX kg} \times \text{MAX kg}}{\text{MAX kg} + \text{MAX kg}} \times 0,00981$ 
$D = 7,1 \text{ kN}$		

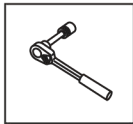

Вкрутить/выкрутить используя инструмент

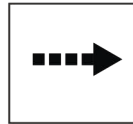

Движение



Поворот



Вкрутить/выкрутить не затягивая

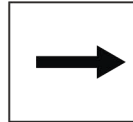





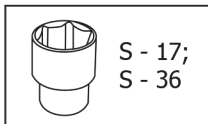
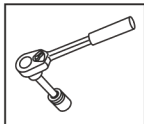



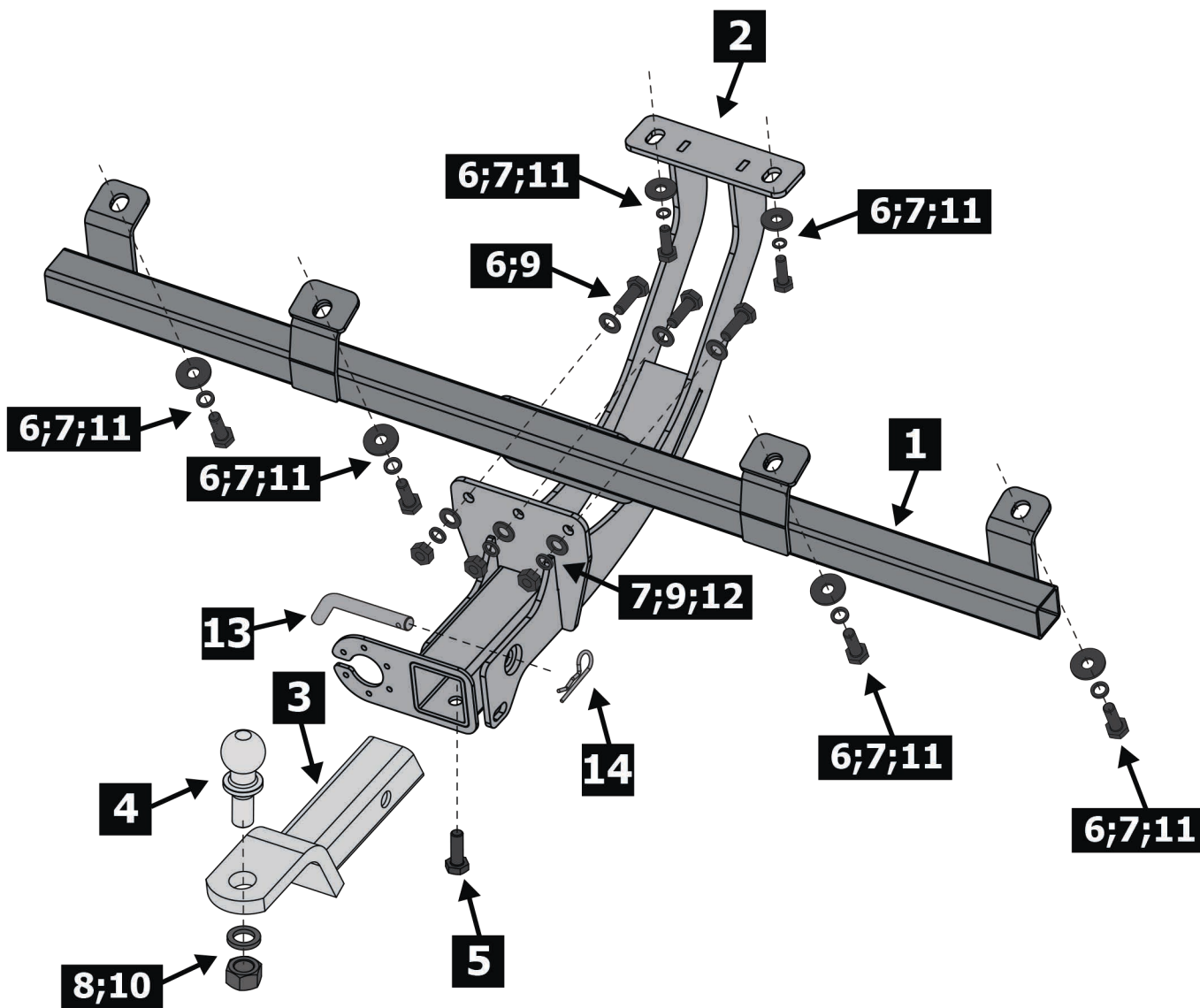

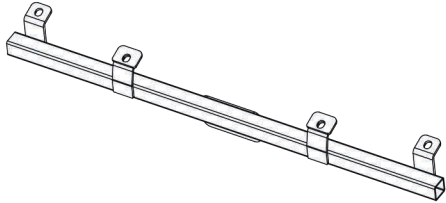
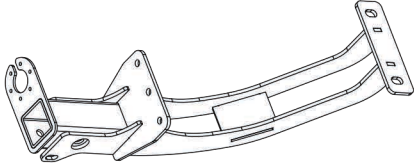
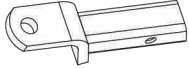
Расположение

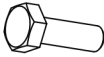
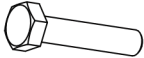
Используемый инструмент:

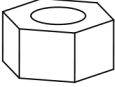

S - 17;
S - 36



1	x1	Балка	
2	x1	Кронштейн	
3	x1	Переходник	
4	x1	Шар	
5	x1	M10x20	
6	x9	M10x1.25x30	
7	x9	∅ 10	
8	x1	∅ 24	
9	x6	∅ 10	
10	x1	M24	
11	x6	∅ 10	
12	x3	M10x1.25	
13	x1	Штифт	
14	x1	Шплинт	